

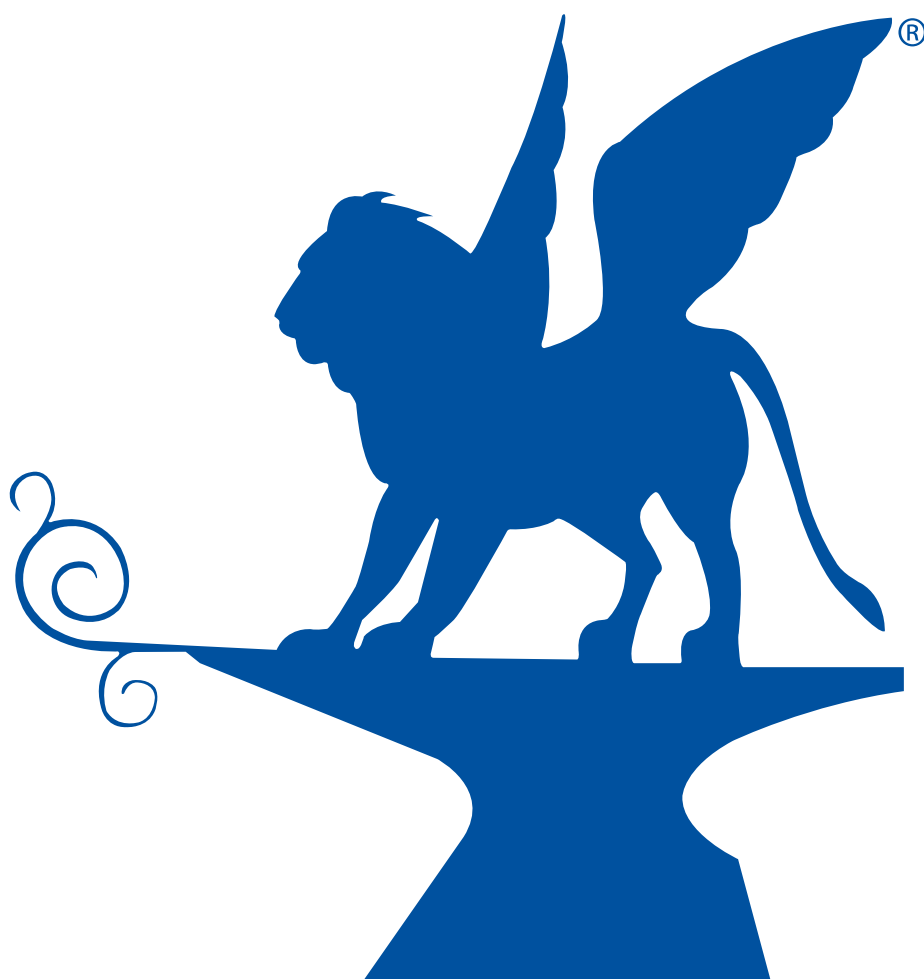

ARTEFERRO
Compendium

Ferro Battuto, Wrought Iron, Hierro Forjado, Schmiedeeisen,
Fer Forge, Ferro Forjado, Smidesjarn, Ковка, Kovano Zeljezo, Fer Forjat

ELEMENTI VARI - VARIOUS ELEMENTS



ind.i.a.® S.
P.
A.
industria italiana arteferro

Art. 181/10
285 x 105 mm
spessore/thickness 30 mm

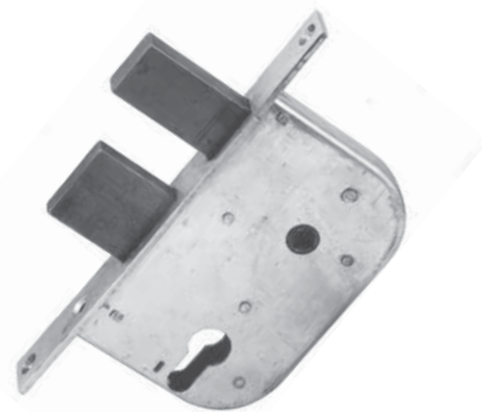
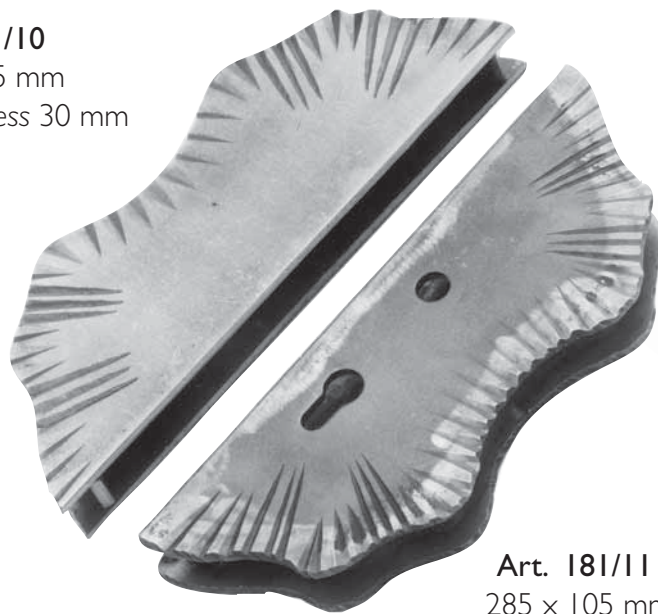

Art. 181/12

Art. 181/11
285 x 105 mm
spessore / thickness 30 mm



Art. 181/15



Art. 169/11
70 x 125 mm
(coppia - couple)

maniglia completa di rosetta
Door handle complete with rosette



ARTEFERRO



Art. 841/5
210 x 290 mm
spessore/thickness 4 mm



Art. 841/6
200 x 150 mm
spessore/thickness 4 mm



Art. 841/1 275 x 160 mm
sp./thickness 3 mm

Art. 841/2 275 x 160 mm
sp./thickness 3 mm

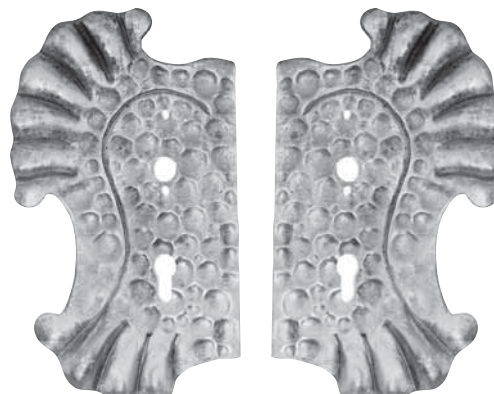

Art. 841/3 275 x 160 mm
sp./thickness 3 mm

Art. 841/4 275 x 160 mm
sp./thickness 3 mm



Art. 842/1 275 x 190 mm
sp./thickness 3 mm

Art. 842/2 275 x 190 mm
sp./thickness 3 mm



Art. 842/3 275 x 190 mm
sp./thickness 3 mm

Art. 842/4 275 x 190 mm
sp./thickness 3 mm



Art. 842/5 290 x 175 mm
sp./thickness 3 mm

Art. 842/6 290 x 175 mm
sp./thickness 3 mm



Art. 842/7 290 x 175 mm
sp./thickness 3 mm

Art. 842/8 290 x 175 mm
sp./thickness 3 mm



Art. 169/12
70 x 135 mm
(coppia - couple)



Art. 169/15
40 x 110 mm
(coppia - couple)

maniglia completa di rosetta
Door handle complete with rosette



Art. 169/14
70 x 135 mm
(coppia - couple)

maniglia completa di rosetta
Door handle complete with rosette



Art. 835/6
Rosetta/Rosette Ø 30 mm



Art. 169/13
80 x 140 mm
(coppia - couple)



Art. 168/5
265 x 48 mm
(coppia - couple)



Art. 168/4
250 x 38 mm
(coppia - couple)

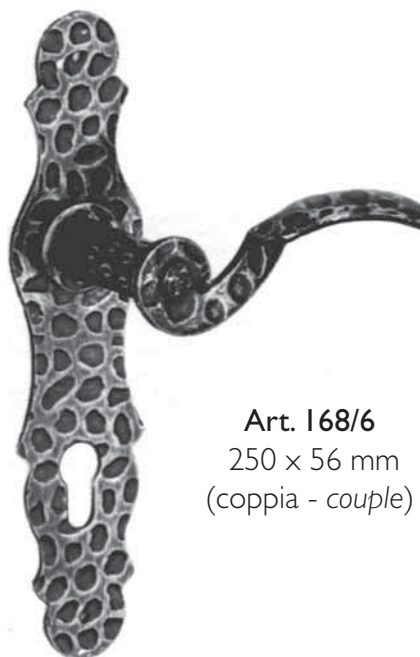

Art. 168/6
250 x 56 mm
(coppia - couple)

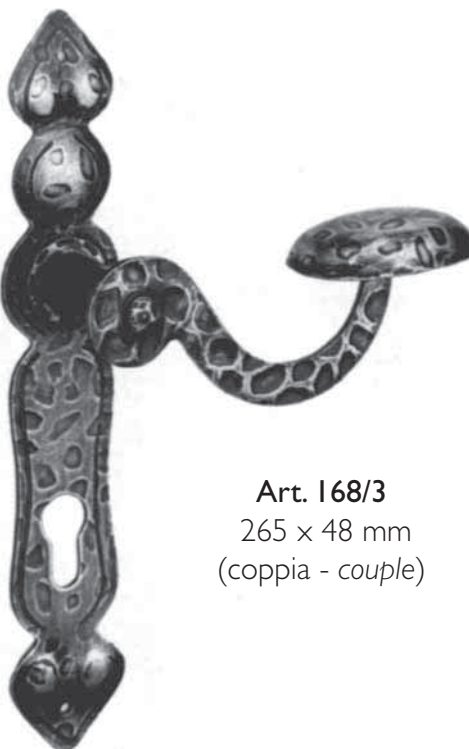

Art. 168/3
265 x 48 mm
(coppia - couple)



Art. 833/4
280 x 60 mm
(coppia - couple)



Art. 836/1
250 x 50 mm
(coppia - couple)

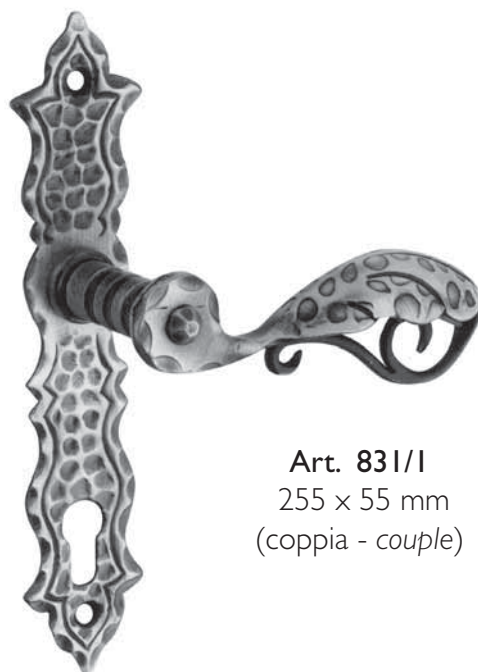

Art. 831/1
255 x 55 mm
(coppia - couple)



ARTEFERRO



Art. 835/8
90 x 50 mm



Art. 835/7
90 x 50 mm



Art. 835/9
100 x 40 mm

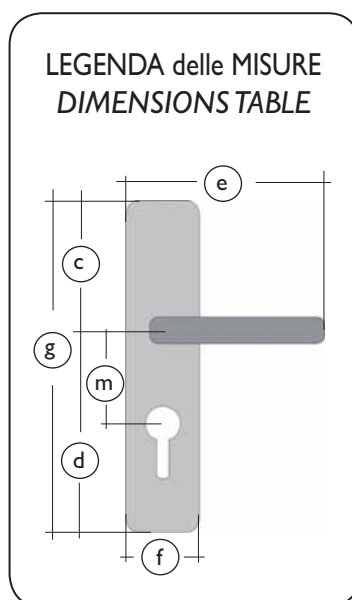
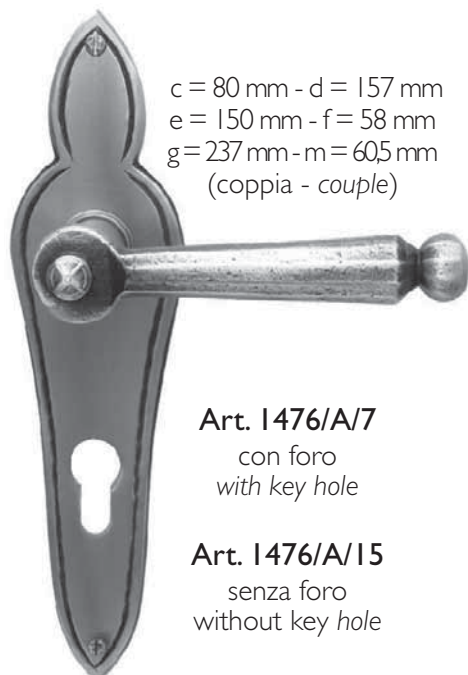
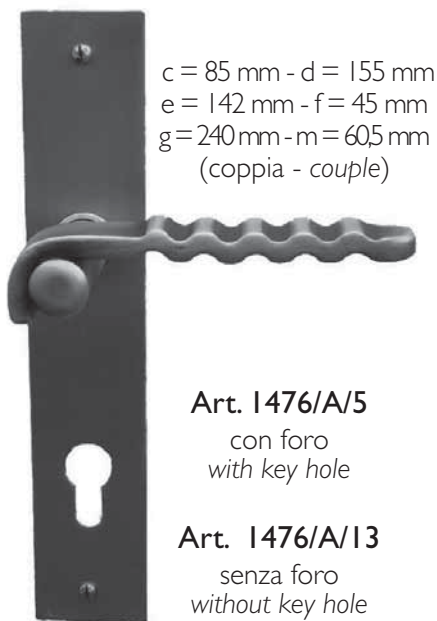
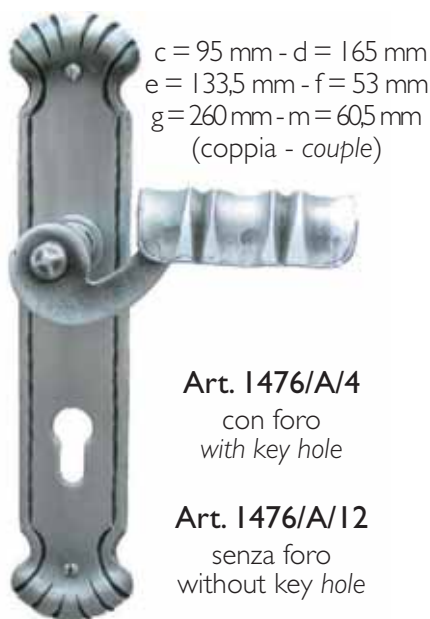
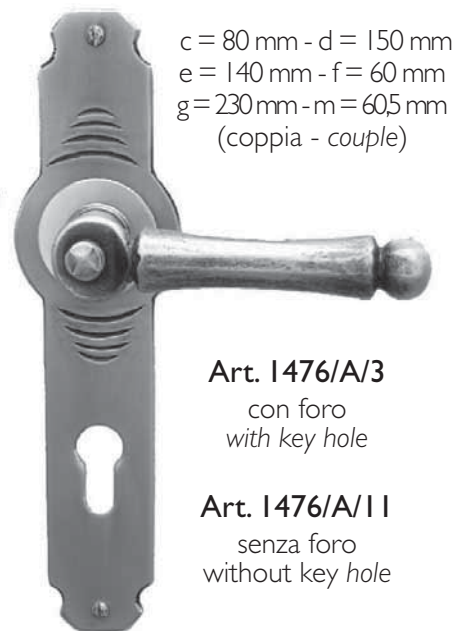
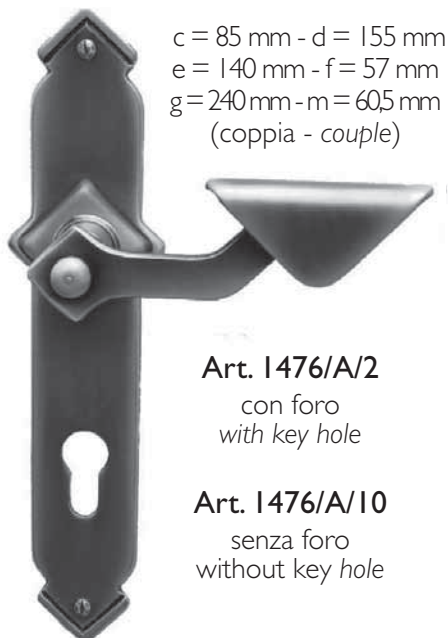
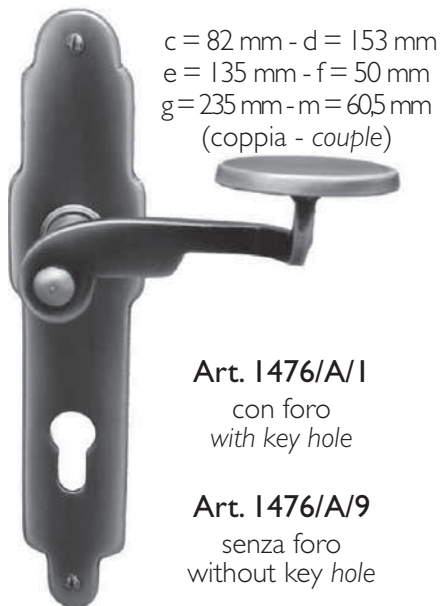



Art. 1476/1
 $a = 129 - b = 100$ mm
 (coppia - couple)

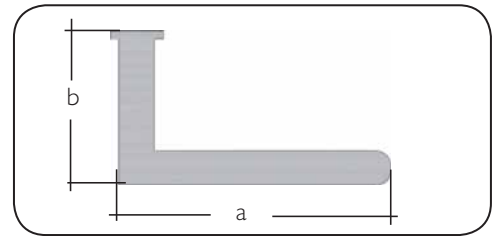

Art. 1476/2
 $a = 130 - b = 72$ mm
 (coppia - couple)

PLACCHE per IMPUGNATURA
 ROSETTES for HANDLES



Art. 1476/3
 $a = 124 - b = 69$ mm
 (coppia - couple)

Art. 1476/9
 $\varnothing 52,5$ mm
 sp./thick. 3 mm



Art. 1476/4
 $a = 130 - b = 79$ mm
 (coppia - couple)

Art. 1476/10
 $\varnothing 53,5$
 $h 63,2$ mm
 sp./thick. 3 mm



Art. 1476/5
 $a = 135 - b = 78$ mm
 (coppia - couple)

Art. 1476/11
 $\varnothing 52,5$ mm
 sp./thick. 3 mm



Art. 1476/6
 $a = 114 - b = 95$ mm
 (coppia - couple)

Art. 1476/12
 $\varnothing 52,5$ mm
 sp./thick. 3 mm



Art. 1476/7
 $a = 133 - b = 75$ mm
 (coppia - couple)

Art. 1476/13
 $\varnothing 53,5$ mm
 $h 63,2$ mm
 sp./thick. 3 mm



Art. 1476/8
 $a = 149 - b = 100$ mm
 (coppia - couple)

Art. 1476/14
 $\varnothing 53,5$ mm
 $h 63,2$ mm
 sp./thick. 3 mm



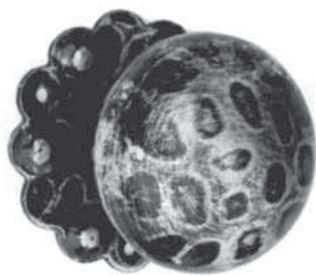

Art. 169/1
 Ø 68 mm
 girevole - rotating

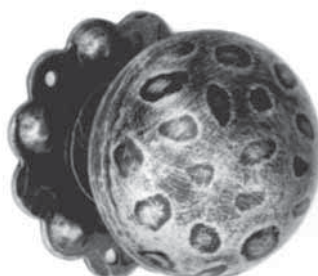

Art. 169/2
 Ø 60 mm
 girevole - rotating



Art. 169/3
 Ø 60 mm
 girevole - rotating

Ø = diameter



Art. 834/1
 Ø 67 mm
 H 75 mm
 girevole - rotating



Art. 834/2
 Ø 67 mm



Art. 838/1
 57 x 57 mm
 H 70 mm
 girevole - rotating



Art. 838/2
 57 x 57 mm
 H 70 mm
 fisso - fixed

Art. 838/3
 60 x 60 mm
 H 45 mm
 fisso - fixed



Art. 838/4
 75 x 75 mm
 H 60 mm
 fisso - fixed



Art. 170/1
Ø 65 mm



Art. 170/2
Ø 65 mm



Art. 170/3
Ø 50 mm



Art. 170/5
Ø 50 mm



Art. 839/5
85 x 35 mm
sp./thick. 2 mm



Art. 839/6
85 x 35 mm
sp./thick. 2 mm



Art. 839/7
85 x 35 mm
sp./thick. 2 mm
foro/hole Ø 14 mm



Art. 839/8
70 x 35 mm
sp./thick. 2 mm



Art. 839/9
100 x 40 mm
sp./thick. 2 mm

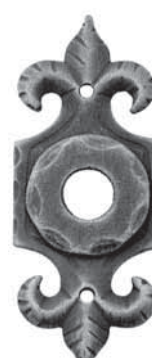

Art. 839/10
100 x 40 mm
sp./thick. 2 mm
foro/hole Ø 14 mm

Ø = diameter



Art. 169/6
250 x 56 mm



Art. 169/7
250 x 38 mm



Art. 169/8
265 x 48 mm



Art. 169/9
265 x 48 mm

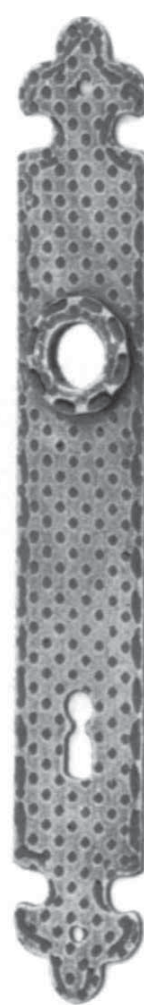

Art. 169/10
250 x 38 mm



Art. 832/5
255 x 50 mm



Art. 832/1
265 x 60 mm



Art. 832/2
220 x 45 mm



Art. 832/3
295 x 60 mm

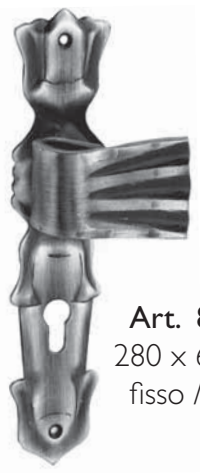

Art. 832/4
280 x 60 mm
fisso / fixed



Art. 832/6
265 x 75 mm



Art. 832/7
265 x 60 mm



Art. 832/8
255 x 65 mm



Art. 833/7
240 x 50 mm



Art. 833/5
255 x 50 mm



Art. 833/8
250 x 53 mm



Art. 833/9
265 x 50 mm



Art. 836/2
275 x 60 mm



Art. 836/3
255 x 65 mm

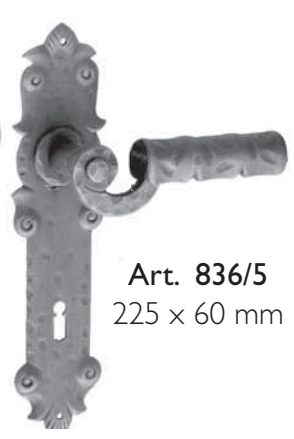

Art. 836/5
225 x 60 mm



Art. 836/6
270 x 40 mm



Art. 836/7
280 x 40 mm



Art. 836/8
255 x 50 mm



Art. 836/9
255 x 50 mm

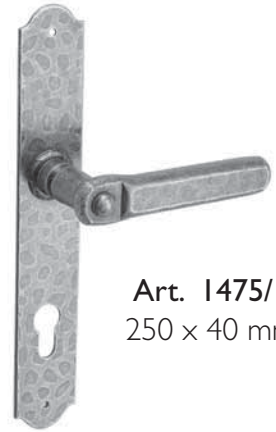

Art. 1475/1
250 x 40 mm

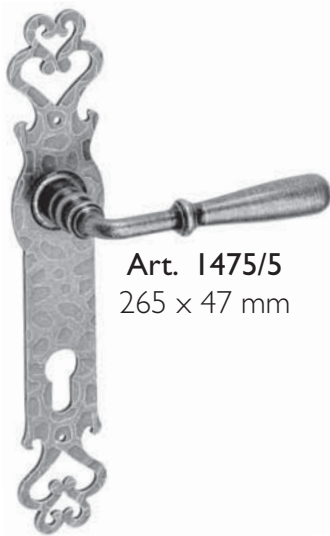

Art. 1475/5
265 x 47 mm

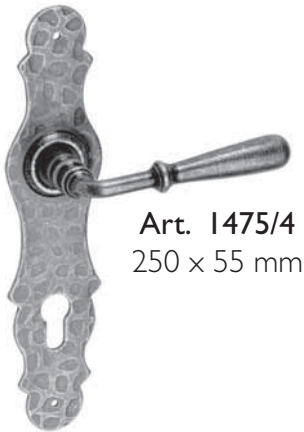

Art. 1475/4
250 x 55 mm

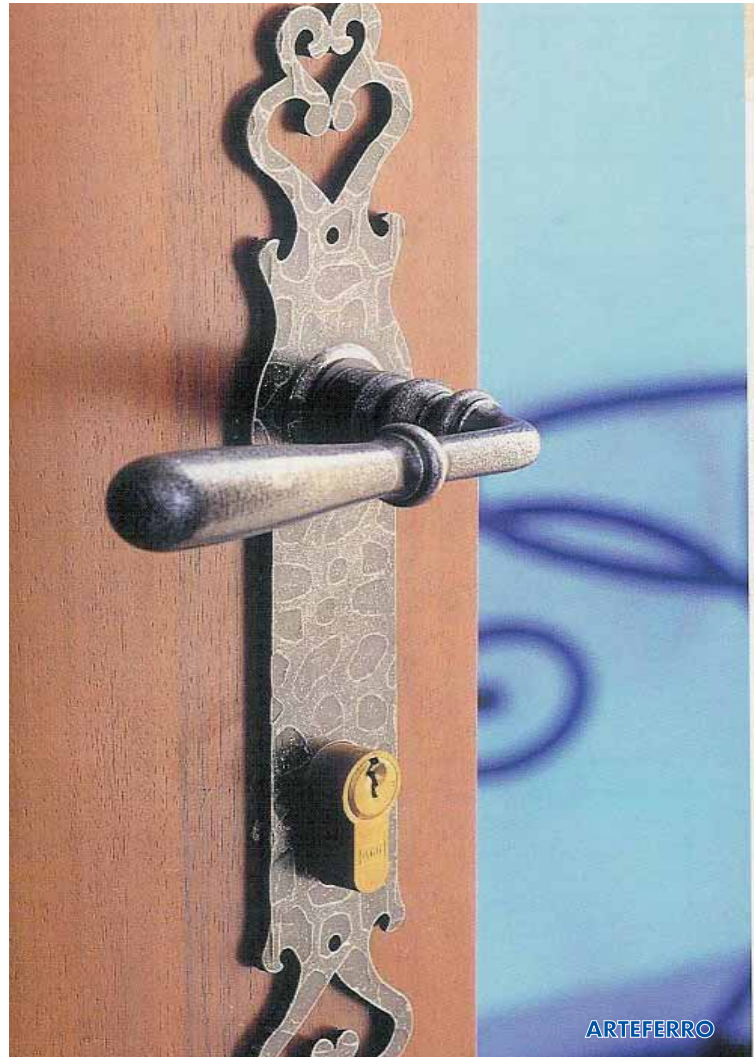

ARTEFERRO



Art. 1475/6
220 x 50 mm

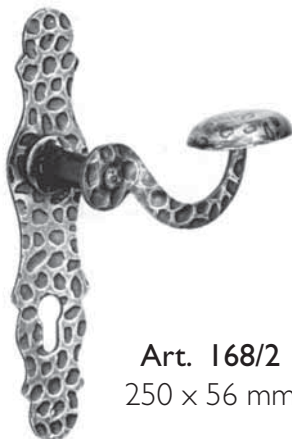

Art. 168/2
250 x 56 mm



Art. 1475/2
270 x 55 mm



Art. 1475/3
250 x 40 mm



Art. 833/6
240 x 260 mm



Art. 834/3
265 x 80 mm



Art. 836/4
275 x 60 mm
girevole / rotating



Art. 839/4
250 x 70 mm
□ 18 mm



Art. 170/6
310 x 60 mm



Art. 839/1
H 300 mm
Ø 32 mm
Rosetta/Rosette
Ø 80 mm



Art. 839/2
H 200 mm
Ø 25 mm
Rosetta/Rosette
Ø 60 mm



Art. 1474/3
315 x 40 mm



Art. 1474/5
Ø 70 mm
Ø 8MA foro filetto
dia 8MA threaded hole

Ø = diameter

Art. 839/3
480 x 80 mm
□ 18 mm



Art. 1474/2
H 340 mm
basi/bases
Ø 90 mm



Art. 1474/1
270 x 55 mm



Art. 833/3
77 x 35 mm



Art. 833/2
Ø 53 mm



Art. 833/1
58 x 58 mm



Art. 1475/7
37 x 75 mm



Art. 835/1
200 x 40 mm



Art. 835/2
160 x 55 mm



Art. 835/3
150 x 45 mm



Art. 835/4
140 x 33 mm



Art. 835/5
190 x 35 mm



Art. 170/7
170 x 105 mm



Art. 837/2
Ø 150 mm
rosetta/rosette
Ø 80 mm



Art. 1474/4
Ø 120 mm
base Ø 90 mm



Art. 837/1
Ø 110 mm
rosetta/rosette
Ø 95 mm



Art. 170/A/6
90 x 33 mm



Art. 170/A/4
90 x 38 mm



Art. 170/A/5
49 x 43 mm



Art. 170/A/10
49 x 43 mm



Art. 837/3
Ø 100 mm
rosetta/rosette
Ø 60 mm



Art. 170/A/8
58 x 27 mm



Art. 170/A/11
58 x 27 mm



Art. 170/A/2
68 x 125 mm



Art. 170/A/7
48 x 48 mm



Art. 170/A/9
48 x 48 mm



Art. 170/A/1
31 x 121 mm



Art. 170/A/3
92 x 55 mm



Art. 837/4
H 145 mm
60 x 2 mm



Art. 837/9
H 145 mm
110 x 2 mm



Art. 837/7
H 95 mm
70 x 2 mm



Art. 170/B/1
45 x 190 mm



Art. 170/B/2
30 x 150 mm



Art. 170/B/3
30 x 105 mm



Art. 170/B/5
81 x 137 mm



Art. 837/5
H 260 mm
55 x 2 mm



Art. 837/10
H 160 mm
120 x 2 mm



Art. 837/8
H 100 mm
70 x 2 mm



Art. 840/4
30 x 160 mm



Art. 840/5
30 x 200 mm



Art. 840/6
50 x 150 mm



Art. 837/6
165 x 70 mm
Ø 15 mm



Art. 169/4
H 250 mm
L 40 mm



Art. 169/5



Art. 840/1
65 x 300 mm



Art. 840/2
65 x 350 mm



Art. 840/3
65 x 400 mm

Ø = diameter





Art. 170/B/4
 Ø 14 mm
 100 x 52 mm
 filetto/threaded
 8 mm



Art. 830/1
 Ø 22 mm
 H 100 mm
 filetto/threaded
 14MA mm



Art. 830/2
 Ø 22 mm
 H 100 mm
 filetto/threaded
 14MA mm



Art. 830/3
 filetto / threaded
 20MA mm
Art. 830/4
 filetto / threaded
 24MA mm



Art. 182/1
 60 x 100 mm
Art. 182/2
 60 x 280 mm

CARDINE a SALDARE
 HINGE for WELDING to POST

CARDINE a MURO
 HINGE for BUILDING into WALL

CARDINE PASSANTE
 HINGE to FASTEN TROUGH POST

CARDINE a REGOLAZIONE ORTOGONALE
 RIGHT-ANGLE ADJUSTMENT HINGE



Art. 164/1
 filetto/threaded
 18MA mm



Art. 164/3
 filetto/threaded
 18MA mm



Art. 164/5
 filetto/threaded
 18MA mm



Art. 830/19
 filetto / thread
 18MA mm

Art. 164/2
 filetto/threaded
 22MA mm

Art. 164/4
 filetto/threaded
 22MA threaded

Art. 164/6
 filetto/threaded
 22MA mm

Art. 830/20
 filetto / threaded
 22MA mm

Art. 830/17
 filetto/threaded
 27MA mm

Art. 830/18
 filetto/threaded
 27MA mm

Art. 830/21
 filetto / threaded
 27MA mm



con CARDINE
 with HINGE
 18MA

PERNO
 PIVOT

PIASTRA
 PLATE

Art. 164/11 **Art. 164/12**

con CARDINE
 with HINGE
 22MA

Art. 164/13 **Art. 164/14**

PIASTRA
 PLATE

con CARDINE
 with HINGE
 18MA **Art. 164/9**

con CARDINE
 with HINGE
 22MA **Art. 164/10**



LUCIDO - POLISHED

Art. 830/5

H 89 mm - Ø 20 mm

Art. 830/6

H 89 mm - Ø 23 mm

Art. 830/7

H 89 mm - Ø 28 mm

LUCIDO - POLISHED

Art. 830/11

H 15 mm - L 60 mm

Art. 830/12

H 20 mm - L 70 mm

Art. 830/13

H 20 mm - L 80 mm

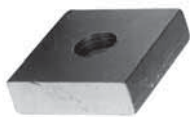

ZINCATO - ZINC PLATED

Art. 830/8

H 89 mm - Ø 20 mm

Art. 830/9

H 89 mm - Ø 23 mm

Art. 830/10

H 89 mm - Ø 28 mm

ZINCATO - ZINC PLATED

Art. 830/14

H 15 mm - L 60 mm

Art. 830/15

H 20 mm - L 70 mm

Art. 830/16

H 20 mm - L 80 mm

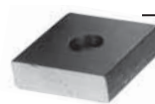

CARDINI CERTIFICATI PER PORTATE ELEVATE - HINGES CERTIFIED FOR HIGH CAPACITY



Art. 181/13
 Ø 38 mm
 H 230 mm
 filetto/threaded
 22MA mm

Art. 181/14
 Ø 32 mm
 H 175 mm
 filetto/threaded
 18MA mm

PERNO
 PIVOT



con CARDINE
 with HINGE
 18MA
Art. 164/7
 da abbinare con
 to be coupled with
 art. 164/9

con CARDINE
 with HINGE
 22MA
Art. 164/8
 da abbinare con
 to be coupled with
 art. 164/10



PRODOTTI CERTIFICATI CE
 LA CERTIFICAZIONE E IL RAPPORTO DEI TEST
 SONO DISPONIBILI SUL SITO
WWW.ARTEFERRO.COM

CE CERTIFIED PRODUCTS
 CERTIFICATION AND TESTED AVAILABLE AT
WWW.ARTEFERRO.COM



	Lt 0,75	Lt 2,50
NERO Forgia Forge BLACK	227/1	227/2
GRAFITE GRAPHITE Gray	227/3	227/4
BIANCO Antico Antique WHITE	227/33	227/34
TESTA di MORO Dark BROWN	227/35	227/36
VERDE Vagone Dark GREEN	227/37	227/38
ROSSO Inglese English RED	227/39	227/40
GRIGIO Perla Pearl GREY	227/41	227/42
GRIGIO Argento Silver GREY	227/43	227/16
GRIGIO Chiaro Light GRAY	227/44	227/18
GRIGIO Nero Black GRAY	227/45	227/20
GRIGIO Scuro Dark GRAY	227/46	227/22
BRONZO BRONZE	227/47	227/24
Vernice TRASPARENTE TRASPARENT Vernish	227/48	227/49
RUGGINE Trasparente RUST COLOUR Coating	227/53	227/54
VERDE Mobili Ind.i.a.'s Furniture GREEN GRAY	227/55	227/56

	Lt 0,25	
Patina ORO GOLD Patina	227/29	
Patina RAME COPPER Patina	227/30	
Patina VERDE GREEN Patina	227/31	
Patina ARGENTO SILVER Patina	227/32	
Patina VERDE RAME Opaco VERDIGRIS MAT Patina	227/50	
Patina ORO Pallido Pale GOLD Patina	227/51	
Patina ORO Antico Antique GOLD Patina	227/52	
RUGGINE Trasparente RUST COLOUR Coating	227/53	
VERDE Mobili Ind.i.a.'s Furniture GREEN GRAY	227/44	
	Lt 1,00	Lt 5,00
DILUENTE Sintetico THINNER	227/27	227/28
DILUENTE Nitro Nitro THINNER	227/57	227/58



GOLA a "V"
"V" GROOVE

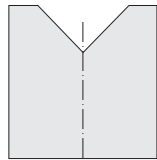

SERIE LEGGERA - n. 1 CUSCINETTO
LIGHT MODEL with nr. 1 BEARING

Cod. art. Art. no.	Ø/dia	SPESSORE WIDTH	PORTATA CAPACITY
844/1	50 mm	20 mm	200 Kg
844/2	60 mm	20 mm	300 Kg
844/3	70 mm	20 mm	300 Kg
844/34	75 mm	20 mm	300 Kg
844/4	80 mm	20 mm	300 Kg
844/5	90 mm	20 mm	300 Kg
844/6	100 mm	20 mm	300 Kg
844/7	120 mm	20 mm	300 Kg
844/8	140 mm	20 mm	300 Kg
844/9	160 mm	20 mm	300 Kg

SERIE PESANTE - n. 2 CUSCINETTI
HEAVY MODEL with nr. 2 BEARINGS

Cod. art. Art. no.	Ø/dia	SPESSORE WIDTH	PORTATA CAPACITY
844/10	100 mm	30 mm	600 Kg
844/11	120 mm	30 mm	600 Kg
844/12	140 mm	30 mm	600 Kg
844/13	160 mm	30 mm	800 Kg
844/14	200 mm	30 mm	800 Kg

SERIE PESANTE con INGRASSATORE
- n. 2 CUSCINETTI -
HEAVY MODEL with GREASE RECEIVER
- nr. 2 BEARINGS -

Cod. Art. Art. no.	Ø/dia	SPESSORE WIDTH	PORTATA CAPACITY
844/15	90 mm	30 mm	600 Kg
844/16	100 mm	30 mm	600 Kg
844/17	120 mm	30 mm	600 Kg
844/18	140 mm	30 mm	600 Kg
844/19	160 mm	30 mm	600 Kg



GOLA a "RAGGIO"
"ROUNDE" GROOVE

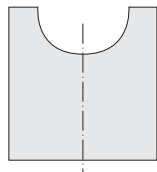

SERIE PESANTE - 10 mm
HEAVY MODEL - 10 mm

Cod. art. Art. no.	Ø/dia	SPESSORE WIDTH	PORTATA CAPACITY
844/29	100 mm	30 mm	600 Kg
844/30	120 mm	30 mm	600 Kg
844/31	140 mm	30 mm	600 Kg
844/32	160 mm	30 mm	600 Kg
844/33	200 mm	30 mm	600 Kg

SERIE LEGGERA - 7,5 mm
LIGHT MODEL - 7,5 mm

Cod. art. Art. no.	Ø/dia	SPESSORE WIDTH	PORTATA CAPACITY
844/20	50 mm	20 mm	300 Kg
844/21	60 mm	20 mm	300 Kg
844/22	70 mm	20 mm	300 Kg
844/23	80 mm	20 mm	300 Kg
844/24	90 mm	20 mm	300 Kg
844/25	100 mm	20 mm	300 Kg
844/26	120 mm	20 mm	300 Kg
844/27	140 mm	20 mm	300 Kg
844/28	160 mm	20 mm	300 Kg

**RUOTE GUIDA
SUPERIORI
CILINDRICHE**
Ø 30 mm



**CILINDRICAL UPPER
GUIDINGWHEELS**
for GATES
dia 30 mm

Art. 845/17

**RUOTE GUIDA
SUPERIORI
CILINDRICHE**
Ø 35 mm



**CILINDRICAL UPPER
GUIDINGWHEELS**
for GATES
dia 35 mm

Art. 846/4



GOLA a "V"
"V" GROOVE

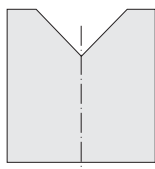

RUOTE con SUPPORTO INTERNO TIPO "F"
WHEELS with INTERNAL SUPPORT MODEL "F"

Cod. art. Art. no.	Ø/dia	SPESSORE WIDTH	CUSCINETTI BEARINGS	PORTATA CAPACITY
845/20	75 mm	20 mm	1	300 Kg
845/1	80 mm	20 mm	1	300 Kg
845/2	90 mm	20 mm	1	300 Kg
845/3	100 mm	20 mm	1	300 Kg
845/4	120 mm	20 mm	1	300 Kg
845/5	120 mm	30 mm	2	600 Kg
845/6	140 mm	20 mm	1	300 Kg
845/7	140 mm	30 mm	2	600 Kg



GOLA a "L"
"L" GROOVE

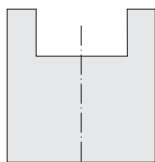

Cod. art. Art. no.	Ø/dia	SPESSORE WIDTH	GOLA GROOVE	CUSCINETTI BEARINGS	PORTATA CAPACITY
845/21	75 mm	18 mm	7 mm	1	300 Kg
845/22	100 mm	22 mm	8 mm	1	300 Kg
845/23	100 mm	30 mm	21 mm	1	300 Kg
845/24	120 mm	22 mm	8 mm	1	300 Kg
845/25	120 mm	30 mm	21 mm	1	300 Kg

PIASTRE GUIDA per CANCELLO
200 mm - 4 OLIVE

GATE GUIDING PLATE
200 mm - 4 GUIDING BEARING



Art. 845/18

PIASTRE GUIDA per CANCELLO
60 mm - 2 OLIVE

GATE GUIDING PLATE
60 mm - 2 GUIDING BEARING

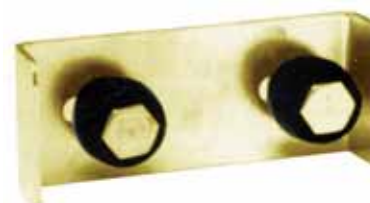

Art. 845/19

SERIE LEGGERA - LIGHT MODEL



GOLA a "L"
"L" GROOVE

Cod. art. Art. no.	Ø/dia	SPESSORE WIDTH	GOLA GROOVE	CUSCINETTI BEARINGS	PORTATA CAPACITY
846/6	60 mm	17 mm	6 mm	1	100 Kg
846/7	75 mm	18 mm	7 mm	1	150 Kg
846/8	90 mm	20 mm	8 mm	1	170 Kg
846/9	100 mm	22 mm	8 mm	1	200 Kg
846/10	120 mm	22 mm	8 mm	1	200 Kg
846/11	140 mm	25 mm	16 mm	1	250 Kg
846/12	160 mm	25 mm	16 mm	1	300 Kg

SERIE PESANTE - HEAVY MODEL

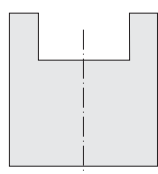

Cod. art. Art. no.	Ø/dia	SPESSORE WIDTH	GOLA GROOVE	CUSCINETTI BEARINGS	PORTATA CAPACITY
846/13	90 mm	25 mm	16 mm	1	200 Kg
846/14	120 mm	30 mm	21 mm	1	400 Kg
846/15	160 mm	30 mm	21 mm	1	500 Kg
846/16	200 mm	30 mm	21 mm	1	600 Kg
846/17	250 mm	32 mm	22 mm	1	800 Kg

PIASTRE GUIDA per CANCELLO
4 OLIVE

GATE GUIDING PLATE
4 GUIDING BEARING

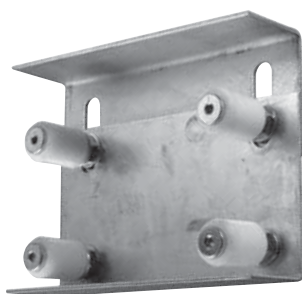

Art. 846/5

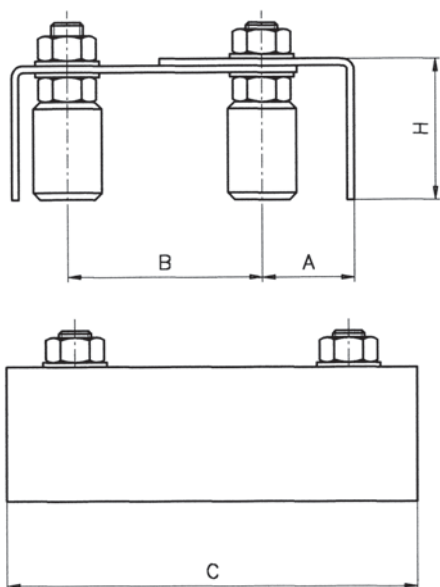

A	40 ÷ 80 mm
B	40 ÷ 50 mm
C	220 mm
H	59 mm



GOLA a "V"
"V" GROOVE

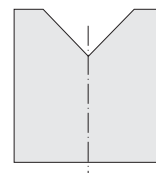

RUOTE con SUPPORTO INTERNO TIPO "I"
WHEELS with INTERNAL SUPPORT MODEL "I"

Cod. art. Art. no.	Ø/dia	SPESSORE WIDTH	GOLA GROOVE	CUSCINETTI BEARINGS	PORTATA CAPACITY
845/8	60 mm	20 mm	20 mm	1	300 Kg
845/9	70 mm	20 mm	20 mm	1	300 Kg
845/10	80 mm	20 mm	20 mm	1	400 Kg
845/11	90 mm	20 mm	20 mm	1	400 Kg
845/12	100 mm	20 mm	20 mm	1	400 Kg
845/13	120 mm	20 mm	20 mm	1	400 Kg
845/14	120 mm	30 mm	30 mm	2	600 Kg
845/15	140 mm	20 mm	20 mm	1	400 Kg
845/16	140 mm	30 mm	30 mm	2	600 Kg



GOLA a "L"
"L" GROOVE

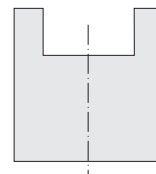

Cod. art. Art. no.	Ø/dia	SPESSORE WIDTH	GOLA GROOVE	CUSCINETTI BEARINGS	PORTATA CAPACITY
845/26	75 mm	18 mm	8 mm	1	180 Kg
845/27	90 mm	20 mm	8 mm	1	200 Kg
845/28	100 mm	22 mm	8 mm	1	220 Kg
845/29	120 mm	25 mm	16 mm	2	400 Kg
845/30	140 mm	25 mm	16 mm	2	420 Kg

GOLA a "L"
"L" GROOVE

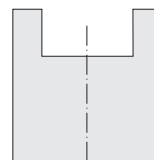

GOLA a "V"
"V" GROOVE

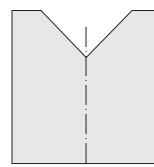

Cod. art. Art. no.	Ø/dia	SPESSORE WIDTH	GOLA GROOVE	CUSCINETTI BEARINGS	PORTATA CAPACITY
846/18	75 mm	25 mm	13 mm	1	200 Kg
846/19	75 mm	25 mm	16 mm	1	200 Kg
846/20	100 mm	25 mm	16 mm	1	400 Kg

Cod. art. Art. no.	Ø/dia	SPESSORE WIDTH	GOLA GROOVE	CUSCINETTI BEARINGS	PORTATA CAPACITY
846/21	75 mm	25 mm		1	200 Kg
846/22	100 mm	25 mm		2	400 Kg

Art. 869/1

150 kg

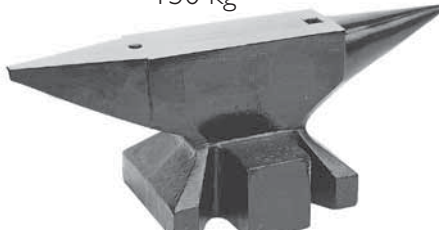

Art. 869/2

H 500 mm

Ø 500 mm

Art. 870/1

50 kg



Art. 870/2

H 580 mm

Ø 350 mm

Art. 870/3

100 kg

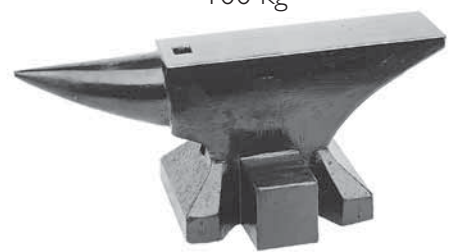

Art. 870/4

H 530 mm

Ø 400 mm

Ø = diameter

INCUDINI
SAGOMATORI

MODELLING
ANVILS



Art. 872/1

Ø 5 mm



Art. 872/2

Ø 10 mm



Art. 872/3

Ø 20 mm



Art. 872/4

Ø 25 mm



Art. 872/5

Ø 30 mm



Art. 872/6

Ø 5 mm



Art. 872/7

Ø 10 mm



Art. 872/8

Ø 15 mm



Art. 872/9

Ø 20 mm



Art. 872/10

Ø 25 mm



Art. 872/11

Ø 30 mm



DIMA
CALIBRATRICE
FORGING TOOLS
and EQUIPEMENT

Art. 871/1

H 840 mm

L 350 mm

INCUDINE PIANO
PLAIN ANVIL



Art. 873/1

INCUDINE INCISORE
ENGRAVING ANVIL



Art. 873/2

INCUDINE INCISORE
ENGRAVING ANVIL



Art. 873/3



ARTEFERRO

SCALPELLI SAGOMATORI PIANI
FLAT MODELLING CHISELS

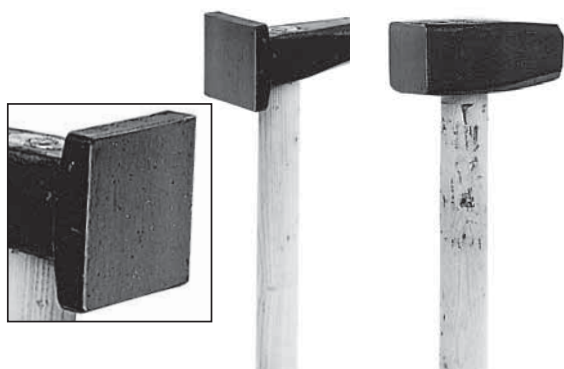

Art. 874/4
70 x 70 mm

Art. 874/5
50 x 50 mm

MAZZETTE - LITTLE SLEDGEHAMMERS



Art. 874/1
1,5 kg

Art. 874/2
1,5 kg

Art. 874/3
2,0 kg

SCALPELLI A COLTELLO - KNIFE SHAPED CHISELS



Art. 875/7
1,0 kg

Art. 875/8
1,5 kg

Art. 875/9
2,0 kg

MAZZE - SLEDGEHAMMERS



Art. 875/1
3,0 kg

Art. 875/2
4,0 kg

Art. 875/3
5,0 kg

SCALPELLI INCISORI - ENGRAVING CHISELS



Art. 875/10
1,0 kg

Art. 875/11
1,5 kg

Art. 875/12
2,0 kg



Art. 875/4
6,0 kg

Art. 875/5
8,0 kg

Art. 875/6
10,0 kg

SCALPELLI SAGOMATORI - MODELLING CHISELS

Ø = diameter



Art. 876/6
Ø 5 mm

Art. 876/7
Ø 10 mm

Art. 876/8
Ø 15 mm

Art. 876/9
Ø 20 mm

Art. 876/10
Ø 25 mm

Art. 876/11
Ø 30 mm



Art. 876/1
Ø 5 mm



Art. 876/2
Ø 10 mm



Art. 876/3
Ø 20 mm



Art. 876/4
Ø 25 mm



Art. 876/5
Ø 30 mm

Ø = diameter

CACCIACUNEO a PUNTA QUADRA
SQUARE TIPPED COTTERS DRIVER



Art. 877/1
□ 10 mm



Art. 877/2
□ 15 mm



Art. 877/3
□ 20 mm



Art. 877/4
□ 25 mm

CACCIACUNEO a PUNTA TONDA
ROUND TIPPED COTTERS DRIVER



Art. 877/5
Ø 10 mm



Art. 877/6
Ø 15 mm



Art. 877/7
Ø 20 mm



Art. 877/8
Ø 25 mm

TENAGLIE STAMPATE - L 500 mm
HOT STAMPED BLACKSMITH'S TONGS - L 500 mm



Art. 878/1



Art. 878/5



Art. 878/2

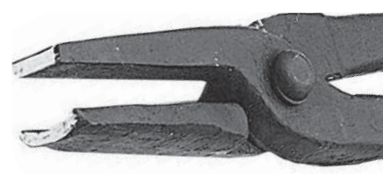

Art. 878/6



Art. 878/3

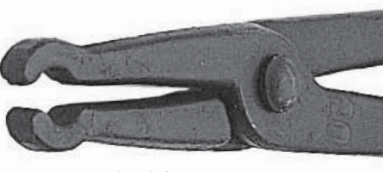

Art. 878/7



Art. 878/4

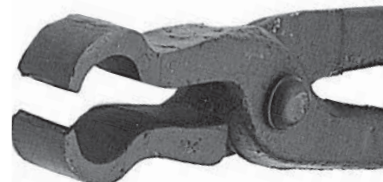

Art. 878/8

TENAGLIE FORGIATE - L 450 mm
FORGED BLACKSMITH'S TONGS - L 500 mm

Art. 879/1



Art. 879/2



Art. 879/3



FORNO SINGOLO - SINGLE OVEN

Art. 1559/1

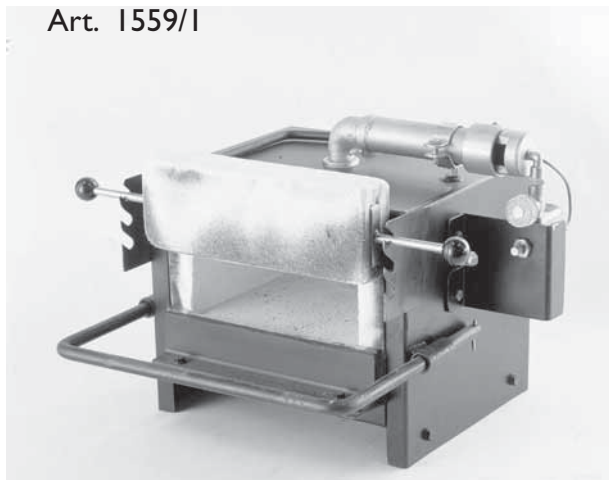

Misure esterne - External measures:

L 310 mm - H 255 mm - P 255 mm

Misure interne - Internal measures:

L 200 mm - H 250 mm - P 90 mm

FORNO DOPPIO - DOUBLE OVEN

Art. 1559/2

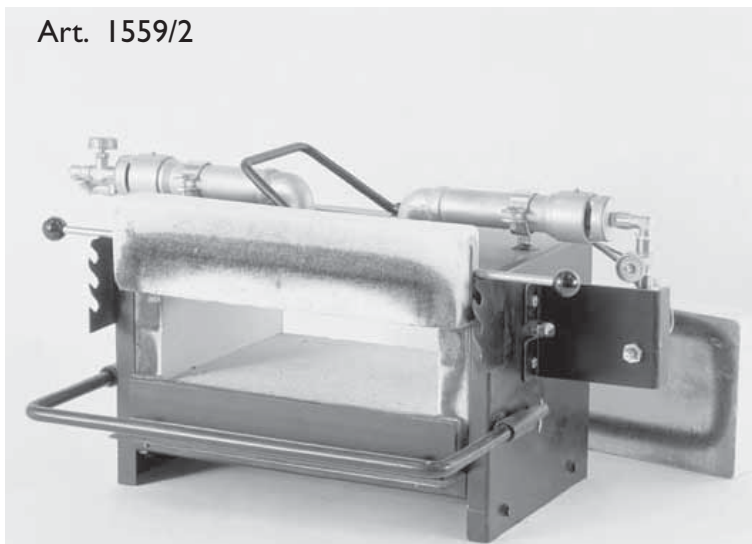

Misure esterne - External measures:

L 410 mm - H 255 mm - P 255 mm

Misure interne - Internal measures:

L 300 mm - H 250 mm - P 90 mm

PICCOLA "FORGIA" SMALL "FORGE"

TRASPORTABILE a MANO
TRANSPORTABLE by HAND

CARATTERISTICHE PRINCIPALI:
MAIN FEATURES:

- Temperatura massima 1300 °C
- Maximum Temperature 1300°C
- Accensione facilitata
- Easy ignition
- Dispositivo di sicurezza in caso di spegnimento accidentale
- Safety device, in case of any sudden or accidental malfunction
- Forno a passaggio totale (avanti / dietro) per l'inserimento anche di verghe lunghe
- Opening on two sides (front / back) to insert long bars
- La camera di combustione è isolata con pannelli in fibrocera e base in refrattario
- The combustion chamber is isolated with ceramic fiber panels made of refractory material
- Lo schermo a chiusura regolabile permette un risparmio di energia e garantisce la massima sicurezza
- The front screen with its adjustable opening, allow for energy saving and guarantees the maximum security)

I FORNI RISPONDONO ALLE VIGENTI
NORMATIVE INTERNAZIONALI DI SICUREZZA
THE OVENS CORRESPOND TO THE
INTERNATIONAL SECURITY SAFETY LAW (EC)

Direttive CEE 89/392 modificate con Direttive
CEE 91/368 e 93/68, Direttive CEE 89/336
modificate dalle Direttive CEE 93/68

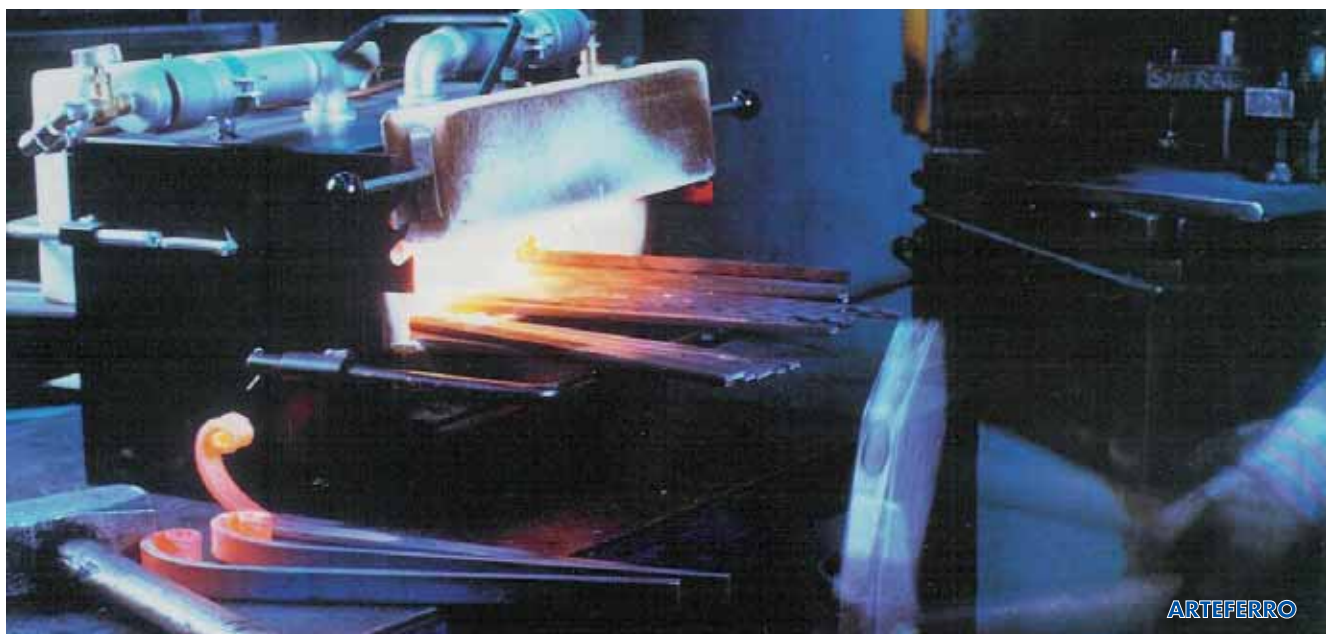

ARTEFERRO

GUANTI da LAVORO - WORKING WELDING and DRIVING GLOVES



Crosta di Maiale
Swine skin
Art. 880/1



Crosta di Maiale
Swine skin
Art. 880/2



Cotone e Lattice
Cotton and lates
Art. 880/3



Lungo per saldatura
Welding glove-long
Art. 880/4



Corto per saldatura
Welding glove-short
Art. 880/5

DISCHI da TAGLIO
CUT-OFF WHELLS

- Art. 881/1
Ø 115 mm
3,40 x 22 mm
- Art. 881/2
Ø 230 mm
3,40 x 22 mm
- Art. 881/3
Ø 300 mm
3,00 x 22 mm
fissi /fix

DISCHI SMERIGLIO
GRINDING WHELLS

- Art. 881/4
Ø 115 mm
6,00 x 22 mm
- Art. 881/5
Ø 230 mm
6,00 x 22 mm



DISCHI LAMELLARI
LAMINATED WHELLS

- Art. 881/6
Ø 115 x 22 mm
grana/grain 40
- Art. 881/7
Ø 230 x 22 mm
grana/grain 60
- Art. 881/8
Ø 115 x 22 mm
grana/grain 80
- Art. 881/9
Ø 115 x 22 mm
grana/grain 120



Ø = diameter

ELETTRODI per SALDATURA - WELDING ELECTRODES



Cod. art./Art. no.	882/1	882/2	882/3
Misure Dimensions	Ø 2,5 mm L 300 mm	Ø 3,25 mm L 350 mm	Ø 3,25 mm L 400 mm
Scatole sul bancale - Boxes per pallet	240	234	160
Pezzi in ogni scatola - Pieces per box	290	180	157
Peso per bancale - Height of pallet	1200 kg	1200 kg	1200 kg

ZINCO LIQUIDO SPRAY
Ideale per piccoli ritocchi
LIQUID ZINC SPRAY
Perfect for "toch-ups"



Art. 185/9

ANTI SPRUZZO di
SALDATURA
ANTI STICK SPRAY
for WELDING



Art. 883/1

SPRAY SBLOCCANTE
UNLOCKING SPRAY



Art. 883/3

ANCORANTE CHIMICO
QUICK CEMENT



Art. 883/4

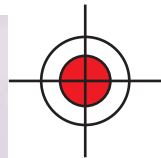

REIMESSKO

Sistema brevettato
DIMA e MISURATORE
per ringhiera di Scale

STAIRCASE
TEMPLATE and MEASURING
Patented System

Art. 882/4

kit di due casse inclusi gli utensili
per il montaggio

Set of two cases including tools for fastening



Il sistema REIMESSKO permette di:

- costruire, dall'inizio alla fine, la ringhiera di una scala, anche a sviluppo irregolare, completamente nella propria officina
- montare velocemente la ringhiera in cantiere;
- risparmiare, per ogni ringhiera, anche 8 - 10 ore di manodopera

The patented REIMESSKO system it is possible to:

- completely build the staircase in the workshop
- easily install the staircase in site with a small amount of handling
- for every staircase you build you can save 8 - 10 hours

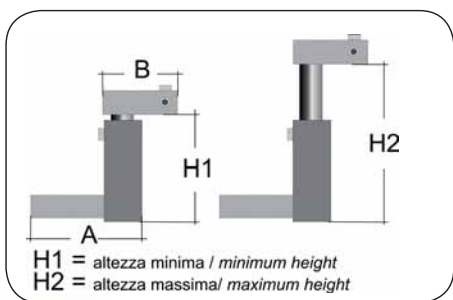

Art. 1905/2
A = 120 mm
B = 85 mm
H1 = 160 mm
H2 = 235 mm



Art. 1905/3
A = 210 mm
B = 155 mm
H1 = 160 mm
H2 = 235 mm



Art. 1905/4
A = 90 mm
B = 55 mm
H1 = 160 mm
H2 = 235 mm



Art. 1905/5
A = 150 mm
B = 85 mm
H1 = 160 mm
H2 = 235 mm



Art. 1905/6
A = 90 mm
B = 55 mm
H1 = 160 mm
H2 = 235 mm



Art. 1905/7
A = 90 mm
B = 55 mm
H1 = 310 mm
H2 = 500 mm



Art. 1905/1
A = 120 mm
B = 55 mm
H1 = 160 mm
H2 = 235 mm



Art. 1905/8
L 200 mm



Art. 1905/9
L 150 mm



Art. 1905/10
L 100 mm



Art. 1905/12
L 80 mm



Art. 1905/13
L 50 mm



Art. 1905/14 Art. 1905/15



Art. 1905/16
foro/hole 35 x 35 mm
H 100 mm
Flange Ø 140 mm



Art. 1905/17
foro/hole
35 x 35 mm



Art. 1905/18
foro/hole
35 x 35 mm



Art. 1905/19

ELEMENTI VARI - VARIOUS ELEMENTS



- 6 x 20 mm - **Art. 41/17**
- 6 x 25 mm - **Art. 41/18**
- 6 x 30 mm - **Art. 41/19**
- 6 x 35 mm - **Art. 41/20**
- 6 x 40 mm - **Art. 41/21**
- 6 x 45 mm - **Art. 41/22**
- 6 x 50 mm - **Art. 41/23**
- 6 x 60 mm - **Art. 41/24**

7 x 25 mm - **Art. 41/13**

- 8 x 8 mm - **Art. 41/14** - (disponibile anche in ottone / available also in brass)
- 8 x 20 mm - **Art. 41/15** - (disponibile anche in ottone / available also in brass)
- 8 x 25 mm - **Art. 41/1** - (disponibile anche in ottone / available also in brass)
- 8 x 30 mm - **Art. 41/4** - (disponibile anche in ottone / available also in brass)
- 8 x 35 mm - **Art. 41/5** - (disponibile anche in ottone / available also in brass)
- 8 x 40 mm - **Art. 41/6** - (disponibile anche in ottone / available also in brass)
- 8 x 45 mm - **Art. 41/16** - (disponibile anche in ottone / available also in brass)
- 8 x 50 mm - **Art. 41/7** - (disponibile anche in ottone / available also in brass)
- 8 x 60 mm - **Art. 41/8** - (disponibile anche in ottone / available also in brass)



Art. 41/10
6 x 40 mm

Art. 41/9
8 x 40 mm



Art. 695/12
13 x 63 mm



testa
head
Ø 17 mm

Art. 41/11
L 25 mm
Ø 8 mm

Art. 41/12
L 30 mm
Ø 8 mm



una punta
one point

Art. 171/37
12 x 12 mm

Art. 171/38
15 x 15 mm

Art. 171/39
20 x 20 mm



due punte
two points

Art. 171/40
15 x 15 mm

Art. 171/41
20 x 20 mm

Art. 171/42
25 x 25 mm



CHIODI FORGIATI / HAND FORGED RIVETS

Art. 1474/6

Testa/Head 30 mm
L 285 mm
sez./sect. 14 x 14 mm

Art. 1474/7

Testa/Head 30 mm
L 210 mm
sez./sect. 12 x 12 mm

Art. 1474/8

Testa/Head 25 mm
L 160 mm
sez./sect. 10 x 10 mm

Art. 1474/9

Testa/Head 20 mm
L 105 mm
sez./sect. 8 x 8 mm

Art. 1474/10

Testa/Head 13 mm
L 70 mm
sez./sect. 5 x 5 mm

Ø = diameter

VITI AUTOFILETTANTI / SELF-TAPPING SCREW



Art. 695/6
Testa/Head
30 x 30 mm
L 90 mm
Ø 10 mm



Art. 695/7
Testa/Head
22 x 22 mm
L 75 mm
Ø 8 mm



Art. 695/8
Testa/Head
16 x 16 mm
L 62 mm
Ø 8 mm



Art. 695/9
Testa/Head
Ø 35 mm
L 90 mm
Ø 10 mm



Art. 695/10
Testa/Head
Ø 24 mm
L 85 mm
Ø 8 mm



Art. 695/11
Testa/Head
Ø 18 mm
L 62 mm
Ø 8 mm



Art. 1405/1
 Base 25 x 8 mm
 Fori/Holes Ø 8,5 mm
 φ 12 x 12 mm



Art. 1405/2
 Base Ø 80 mm
 Fori/Holes Ø 8,5 mm
 φ 12 x 12 mm



Art. 1405/3
 Base Ø 80 mm
 Fori/Holes Ø 8,5 mm
 Ø 16 mm

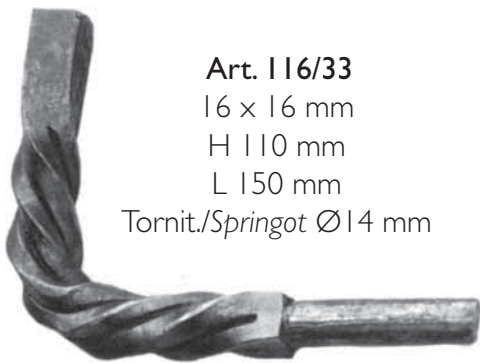

Art. 116/33
 16 x 16 mm
 H 110 mm
 L 150 mm
 Tornit./Springot Ø 14 mm

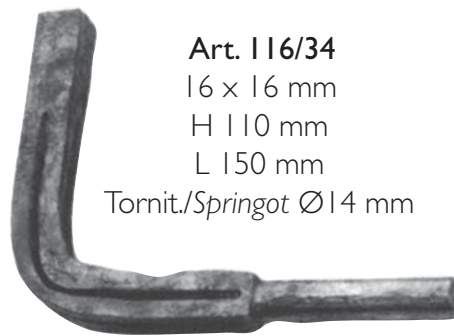

Art. 116/34
 16 x 16 mm
 H 110 mm
 L 150 mm
 Tornit./Springot Ø 14 mm



Art. 116/35
 Ø 65 mm
 8 mm
 Foro/Hole Ø 15 mm



Art. 94/A/1
 H 160 mm
 L 95 mm



Art. 94/A/2
 H 160 mm
 L 95 mm



ARTEFERRO



Art. 82/2
10 x 5 mm
H 105 mm



Art. 30/6
8 x 8 mm
H 75 mm



Art. 81/2
8 x 8 mm
H 125 mm



Art. 83/9
8 x 8 mm
H 120 mm



Art. 83/2
8 x 8 mm
H 120 mm



Art. 83/4
8 x 8 mm
H 120 mm



Art. 83/6
8 x 8 mm
H 120 mm



Art. 83/13
8 x 8 mm
H 120 mm



Art. 83/11
8 x 8 mm
H 120 mm



Art. 89/4
8 x 8 mm
H 55 mm



Art. 83/10
8 x 8 mm
H 60 mm



Art. 83/3
8 x 8 mm
H 60 mm



Art. 83/5
8 x 8 mm
H 60 mm



Art. 83/7
8 x 8 mm
H 60 mm



Art. 83/8
8 x 8 mm
H 60 mm



Art. 83/12
8 x 8 mm
H 60 mm



Art. 81/6
8 x 8 mm
L 120 mm



Art. 81/8
8 x 8 mm
L 110 mm



Art. 82/8
20 x 3 mm
L 135 mm



Art. 198/1
20 x 6 mm
L 140 mm



Art. 85/1
8 x 8 mm
L 125 mm



Art. 34/3
12 x 12 mm
H 175 mm
L 110 mm



Art. 81/4
8 x 8 mm
L 90 mm



Art. 82/6
Ø 10 mm
L 90 mm

Art. 82/4
Ø 8 mm
L 90 mm



Art. 88/L/2
14 x 8 mm
L 135 mm



Art. 85/6
12 x 12 mm
L 225 mm

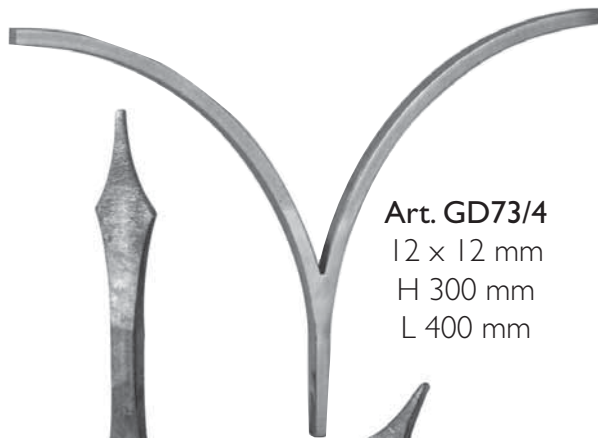

Art. GD73/4
12 x 12 mm
H 300 mm
L 400 mm



Art. 40/B/8
12 x 12 mm
L 220 mm



Art. 70/B/7
12 x 12 mm
190 x 70 mm

Art. 40/B/8
14 x 14 mm
L 220 mm



ARTEFERRO



Art. 852/8

spess./thick. 6 mm
H 70 mm - L 1218 mm

Art. 852/9

spess./thick. 2 mm
H 45 mm - L 1212 mm



Art. 852/10

spess./thick. 8 mm
H 124 mm - L 1206 mm

Art. 852/11

spess./thick. 2 mm
H 45 mm - L 1215 mm



Art. 852/6

spess./thick. 6 mm
H 84 mm - L 1152 mm

Art. 852/7

spess./thick. 2 mm
H 45 mm - L 1213 mm



Art. 852/12

spess./thick. 6 mm
H 70 mm - L 1196 mm

Art. 852/13

spess./thick. 2 mm
H 45 mm - L 1212 mm



Art. 852/14

spess./thick. 6 mm
H 84 mm - L 1160 mm

Art. 852/15

spess./thick. 2 mm
H 45 mm - L 1242 mm



Art. 852/4

spess./thick. 8 mm
H 124 mm - L 1129 mm



Art. 852/5

spess./thick. 6 mm
H 84 mm - L 1140 mm



ARTEFERRO



Art. 1813/1

14 x 6 mm
H 155 mm
L 755 mm

Art. 1813/3

14 x 6 mm
H 155 mm
L 580 mm

Art. 1813/4

14 x 6 mm
H 155 mm
L 415 mm



Art. 1813/2

14 x 6 mm
H 155 mm
L 250 mm



Art. 1813/6

14 x 6 mm
H 190 mm
L 960 mm

Art. 1813/5

14 x 6 mm
H 190 mm
L 580 mm



ARTEFERRO



spess./thick. 3 mm - H 55 mm - L 1000 mm

Art. 1409/1

liscio/plain

Art. 1410/1

coniato/hammered



spess./thick. 3 mm - H 55 mm - L 990 mm

Art. 1409/2

liscio/plain

Art. 1410/2

coniato/hammered



spess./thick. 3 mm - H 55 mm - L 990 mm

Art. 1409/3

liscio/plain

Art. 1410/3

coniato / hammered



spess./thick. 3 mm - H 45 mm - L 990 mm

Art. 1409/4

liscio/plain

Art. 1410/4

coniato/hammered



spess./thick. 3 mm - H 37 mm - L 990 mm

Art. 1409/5

liscio/plain

Art. 1410/5

coniato/hammered



spess./thick. 3 mm - H 63 mm - L 960 mm

Art. 1409/6

liscio/plain

Art. 1410/6

coniato/hammered



spess./thick. 3 mm - H 55 mm - L 960 mm

Art. 1409/7

liscio/plain

Art. 1410/7

coniato / hammered



spess./thick. 3 mm - H 55 mm - L 993 mm

Art. 1409/8

liscio/plain

Art. 1410/8

coniato/hammered



Art. 1411/1

12 x 6 mm - H 165 mm - L 1230 mm



Art. 1411/2

12 x 6 mm - H 165 mm - L 1160 mm - incl. 30°



Art. 1411/3

spess./thickness 2 mm - H 45 mm - L 1230 mm



Art. 1411/5

spess./thickness 6 mm - H 84 mm - L 1225 mm

Art. 1411/4

spess./thickness 6 mm - H 84 mm - L 1250 mm

incl. 30°



Art. 1411/6

10 x 5 mm
H 200 mm
L 200 mm



Art. 1411/9

spess./thick.
5 mm
Ø 100 mm



12 x 12 mm

Art. 1321/1

100 x 100 mm

Art. 1321/3

120 x 125 mm

14 x 14 mm

Art. 1321/2

100 x 100 mm

Art. 1321/4

120 x 125 mm



12 x 12 mm

Art. 1321/5

100 x 100 mm

Art. 1321/7

120 x 125 mm

14 x 14 mm

Art. 1321/6

100 x 100 mm

Art. 1321/8

120 x 125 mm



12 x 12 mm

Art. 1321/9

100 x 100 mm

Art. 1321/11

120 x 125 mm

14 x 14 mm

Art. 1321/10

100 x 100 mm

Art. 1321/12

120 x 125 mm





Art. 1412/1
coniato
hammered

Art. 1413/1
liscio/plain

H 240 x L 215 mm



Art. 1412/4
coniato
hammered

Art. 1413/4
liscio/plain

H 240 x L 240 mm



Art. 1412/7
coniato
hammered

Art. 1413/7
liscio/plain

H 225 x L 175 mm



Art. 1412/10
coniato
hammered

Art. 1413/10
liscio/plain

H 225 x L 150 mm



Art. 1412/13
coniato
hammered

Art. 1413/13
liscio/plain

H 215 x L 200 mm



Art. 1412/16
coniato
hammered

Art. 1413/16
liscio/plain

H 240 x L 210 mm



Art. 1412/19
coniato
hammered

Art. 1413/19
liscio/plain

H 235 x L 125 mm



Art. 1412/22
coniato
hammered

Art. 1413/22
liscio/plain

H 200 x L 225 mm



Art. 1412/25
coniato
hammered

Art. 1413/25
liscio/plain

H 235 x L 150 mm



Art. 1412/2
coniato
hammered

Art. 1413/2
liscio/plain

H 215 x L 215 mm



Art. 1412/5
coniato
hammered

Art. 1413/5
liscio/plain

H 240 x L 135 mm



Art. 1412/8
coniato
hammered

Art. 1413/8
liscio/plain

H 235 x L 185 mm



Art. 1412/11
coniato
hammered

Art. 1413/11
liscio/plain

H 225 x L 200 mm



Art. 1412/14
coniato
hammered

Art. 1413/14
liscio/plain

H 230 x L 165 mm



Art. 1412/17
coniato
hammered

Art. 1413/17
liscio/plain

H 245 x L 195 mm



Art. 1412/20
coniato
hammered

Art. 1413/20
liscio/plain

H 230 x L 165 mm



Art. 1412/23
coniato
hammered

Art. 1413/23
liscio/plain

H 220 x L 220 mm



Art. 1412/26
coniato
hammered

Art. 1413/26
liscio/plain

H 220 x L 180 mm



Art. 1412/3
coniato
hammered

Art. 1413/3
liscio/plain

H 240 x L 160 mm



Art. 1412/6
coniato
hammered

Art. 1413/6
liscio/plain

H 230 x L 185 mm



Art. 1412/9
coniato
hammered

Art. 1413/9
liscio/plain

H 215 x L 120 mm



Art. 1412/12
coniato
hammered

Art. 1413/12
liscio/plain

H 215 x L 190 mm



Art. 1412/15
coniato
hammered

Art. 1413/15
liscio/plain

H 245 x L 170 mm



Art. 1412/18
coniato
hammered

Art. 1413/18
liscio/plain

H 225 x L 195 mm



Art. 1412/21
coniato
hammered

Art. 1413/21
liscio/plain

H 210 x L 170 mm



Art. 1412/24
coniato
hammered

Art. 1413/24
liscio/plain

H 210 x L 200 mm



Art. 1412/27
coniato
hammered

Art. 1413/27
liscio/plain

H 250 x L 250 mm



Art. 1414/1
coniato
hammered

Art. 1414/12
liscio/plain

H 250 x L 80 mm



Art. 1414/2
coniato
hammered

Art. 1414/13
liscio/plain

H 250 x L 130 mm



Art. 1414/3
coniato
hammered

Art. 1414/14
liscio/plain

H 250 x L 135 mm



Art. 1414/4
coniato
hammered

Art. 1414/15
liscio/plain

H 250 x L 125 mm



Art. 1414/5
coniato
hammered

Art. 1414/16
liscio/plain

H 250 x L 95 mm



Art. 1414/6
coniato
hammered

Art. 1414/17
liscio/plain

H 250 x L 120 mm



Art. 1414/7
coniato
hammered

Art. 1414/18
liscio/plain

H 250 x L 90 mm



Art. 1414/8
coniato
hammered

Art. 1414/19
liscio/plain

H 250 x L 110 mm



Art. 1414/9
coniato
hammered

Art. 1414/20
liscio/plain

H 250 x L 110 mm



Art. 1414/10
coniato
hammered

Art. 1414/21
liscio/plain

H 250 x L 120 mm



Art. 1412/28
coniato
hammered

Art. 1413/28
liscio/plain

H 220 x L 170 mm



Art. 1414/12
coniato
hammered

Art. 1414/22
liscio/plain

H 315 x L 2450 mm

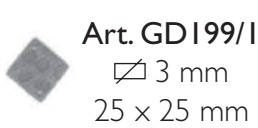

Art. GD199/1

∅ 3 mm
25 x 25 mm



Art. GD199/3

∅ 3 mm
60 x 160 mm



Art. GD199/4

∅ 3 mm
60 x 160 mm



Art. GD199/5

∅ 3 mm
120 x 160 mm



Art. GD199/6

∅ 3 mm
150 x 230 mm



Art. GD199/2

∅ 3 mm
120 x 120 mm



Art. GD199/12

fasciette per
collars for



Art. GD199/7

∅ 3 mm
30 x 70 mm

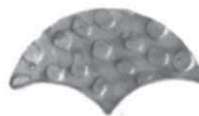

Art. GD199/8

∅ 3 mm
80 x 70 mm



Art. GD199/10

fasciette per
collars for



Art. GD199/11

∅ 3 mm
45 x 25 mm



Art. GD199/16

∅ 3 mm
75 x 230 mm



Art. GD199/17

∅ 3 mm
75 x 230 mm



Art. GD199/13

∅ 3 mm
40 x 105 mm



Art. GD199/14

∅ 3 mm
40 x 105 mm



Art. GD199/9

fasciette per
collars for



Art. GD199/15

∅ 3 mm
80 x 105 mm

Da art. 850/1 ad art. 850/26 : spessore 6 mm - H 170 mm - L 130 mm / thickness 6 mm - H 170 mm - L 130 mm

● Da art. 850/27 ad art. 850/52 : spessore 3 mm - H 80 mm - L 55 mm / thickness 3 mm - H 80 mm - L 55 mm
e disegno diverso rispetto all'immagine / and drawing different from picture)



Art. 850/1

● Art. 850/27



Art. 850/2

● Art. 850/28



Art. 850/3

● Art. 850/29



Art. 850/4

● Art. 850/30



Art. 850/5

● Art. 850/31



Art. 850/6

● Art. 850/32



Art. 850/7

● Art. 850/33



Art. 850/8

● Art. 850/34



Art. 850/9

● Art. 850/35



Art. 850/10

● Art. 850/36



Art. 850/11

● Art. 850/37



Art. 850/12

● Art. 850/38



Art. 850/13

● Art. 850/39



Art. 850/14

● Art. 850/40



Art. 850/15

● Art. 850/41



Art. 850/16

● Art. 850/42



Art. 850/17

● Art. 850/43



Art. 850/18

● Art. 850/44



Art. 850/19

● Art. 850/45



Art. 850/20

● Art. 850/46



Art. 850/21

● Art. 850/47



Art. 850/22

● Art. 850/48



Art. 850/24

● Art. 850/50



Art. 850/25

● Art. 850/51



Art. 850/26

● Art. 850/52



Art. 850/23

● Art. 850/49

NUMERI
NUMBERS
☐ 3 mm



Art. 851/12

H 143 L 186
per un numero
for one number

Art. 851/13

H 169 L 212
fino a 3 numeri
up to 3 numbers

Art. 851/14

H 169 L 302
fino a 5 numeri
up to 5 numbers

Art. 851/15

H 169 L 392
fino a 7 numeri
up to 7 numbers



Art. 851/16

H 145 - L 193
fino a 3 numeri
up to 3 numbers

Art. 851/17

H 145 - L 273
fino a 5 numeri
up to 5 numbers

Art. 851/18

H 151 - L 353
fino a 7 numeri
up to 7 numbers



Art. 851/11
80 x 40 mm



Art. 851/1
80 x 40 mm



Art. 851/2
80 x 40 mm



Art. 851/3
80 x 40 mm



Art. 851/4
80 x 40 mm



Art. 851/5
80 x 40 mm



Art. 852/1
☐ 12 mm
H 290 mm
L 230 mm



Art. 851/6
80 x 40 mm



Art. 851/7
80 x 40 mm



Art. 851/8
80 x 40 mm



Art. 851/9
80 x 40 mm



Art. 851/10
80 x 40 mm



Art. 852/2
☐ 12 mm
H 240 mm
L 180 mm



H 60 / 100 mm

● SOLO PER QUANTITA'
ONLY FOR QUANTITIES

Art. 848/1



H 405 mm - L 255 mm
P 90 mm
ghisa/cast iron

- Lettera / Letter "A" Art. 171/11
- Lettera / Letter "B" Art. 171/12
- Lettera / Letter "C" Art. 171/13
- Lettera / Letter "D" Art. 171/14
- Lettera / Letter "E" Art. 171/15
- Lettera / Letter "F" Art. 171/16
- Lettera / Letter "G" Art. 171/17
- Lettera / Letter "H" Art. 171/18
- Lettera / Letter "I" Art. 171/19
- Lettera / Letter "J" Art. 171/20
- Lettera / Letter "K" Art. 171/21
- Lettera / Letter "L" Art. 171/22
- Lettera / Letter "M" Art. 171/23
- Lettera / Letter "N" Art. 171/24
- Lettera / Letter "O" Art. 171/25
- Lettera / Letter "P" Art. 171/26
- Lettera / Letter "Q" Art. 171/27
- Lettera / Letter "R" Art. 171/28
- Lettera / Letter "S" Art. 171/29
- Lettera / Letter "T" Art. 171/30
- Lettera / Letter "U" Art. 171/31
- Lettera / Letter "V" Art. 171/32
- Lettera / Letter "W" Art. 171/33
- Lettera / Letter "X" Art. 171/34
- Lettera / Letter "Y" Art. 171/35
- Lettera / Letter "Z" Art. 171/36



- Art. 849/1
Bianco/White
- Art. 849/2
Nero/Black
- Art. 849/3
Rosso/Red
- Art. 849/4
Verde/Green



Art. 848/2
H 455 mm - L 400 mm
P 155 mm
ghisa/cast iron



H 120 mm

- No. "1" Art. 171/1
- No. "2" Art. 171/2
- No. "3" Art. 171/3
- No. "4" Art. 171/4
- No. "5" Art. 171/5
- No. "6" Art. 171/6
- No. "7" Art. 171/7
- No. "8" Art. 171/8
- No. "9" Art. 171/9
- No. "0" Art. 171/0



Art. 5069/3
H 1100 mm
Base 330 x 240 mm
ghisa/cast iron



Art. 10314/1
762 x 762 mm



Art. 10314/2
698 x 965 mm



Art. 10314/3
482 x 673 mm



Art. 10314/4
546 x 546 mm



Art. 10315/1
635 x 508 mm



Art. 10315/2
635 x 546 mm



Art. 10315/3
685 x 698 mm



Art. 10316/1
787 x 571 mm



Art. 10315/6
558 x 520 mm



Art. 10315/4
736 x 558 mm



Art. 10316/7
610 x 570 mm



Art. 10316/8
558 x 533 mm



Art. 10316/3
635 x 406 mm



Art. 10316/4
774 x 444 mm



Art. 10316/5
698 x 406 mm



Art. 10316/2
736 x 520 mm

ACCESSORI - ACCESSORIES



Art. 10314/5
127 mm



Art. 10314/6
305 mm



Art. 10314/7
305 mm



Art. 10314/8
305 mm

ARIETE - ARIES



spess./thick. 3 mm
Ø 260 mm

Art. 892/2
grezzo/unpainted

Art. 10395/1
verniciato/painted

Art. 10393/9
con ganci e verniciato
with hook and painted

TORO - TAURUS



spess./thick. 3 mm
Ø 260 mm

Art. 892/1
grezzo/unpainted

Art. 10395/2
verniciato/painted

Art. 10393/1
con ganci e verniciato
with hook and painted

GEMELLI - GEMINI



spess./thick. 3 mm
Ø 260 mm

Art. 891/3
grezzo/unpainted

Art. 10395/3
verniciato/painted

Art. 10393/2
con ganci e verniciato
with hook and painted

CANCRO - CANCER



spess./thick. 3 mm
Ø 260 mm

Art. 891/6
grezzo/unpainted

Art. 10395/4
verniciato/painted

Art. 10393/3
con ganci e verniciato
with hook and painted

LEONE - LION



spess./thick. 3 mm
Ø 260 mm

Art. 892/4
grezzo/unpainted

Art. 10395/5
verniciato/painted

Art. 10393/4
con ganci e verniciato
with hook and painted

VERGINE - VIRGO



spess./thick. 3 mm
Ø 260 mm

Art. 892/5
grezzo/unpainted

Art. 10395/6
verniciato/painted

Art. 10393/5
con ganci e verniciato
with hook and painted

BILANCIA - LIBRA



spess./thick. 3 mm
Ø 260 mm

Art. 892/6
grezzo/unpainted

Art. 10395/7
verniciato/painted

Art. 10393/6
con ganci e verniciato
with hook and painted

SCORPIONE - SCORPIO



spess./thick. 3 mm
Ø 260 mm

Art. 892/3
grezzo/unpainted

Art. 10395/8
verniciato/painted

Art. 10393/7
con ganci e verniciato
with hook and painted

SAGITTARIO - SAGITTARIUS



spess./thick. 3 mm
Ø 260 mm

Art. 891/1
grezzo/unpainted

Art. 10395/9
verniciato/painted

Art. 10393/8
con ganci e verniciato
with hook and painted

CAPRICORNO - CAPRICORN



spess./thick. 3 mm
Ø 260 mm

Art. 891/2
grezzo unpainted

Art. 10395/10
verniciato/painted

Art. 10393/12
con ganci e verniciato
with hook and painted

ACQUARIO - AQUARIUS



spess./thick. 3 mm
Ø 260 mm

Art. 891/4
grezzo/unpainted

Art. 10395/11
verniciato/painted

Art. 10393/10
con ganci e verniciato
with hook and painted

PESCI - PISCES



spess./thick. 3 mm
Ø 260 mm

Art. 891/5
grezzo/unpainted

Art. 10395/12
verniciato/painted

Art. 10393/11
con ganci e verniciato
with hook and painted



spess./thick. 3 mm
Ø 260 mm

Art. 1538/1
grezzo/unpainted

Art. 1536/1
con ganci - grezzo
with hook - unpainted

Art. 1532/1
verniciato/painted

Art. 1530/1
con ganci e verniciato
with hook and painted



spess./thick. 3 mm
Ø 260 mm

Art. 1538/2
grezzo/unpainted

Art. 1536/2
con ganci - grezzo
with hook - unpainted

Art. 1532/2
verniciato/painted

Art. 1530/2
con ganci e verniciato
with hook and painted



spess./thick. 3 mm
Ø 260 mm

Art. 1538/3
grezzo/unpainted

Art. 1536/3
con ganci - grezzo
with hook - unpainted

Art. 1532/3
verniciato/painted

Art. 1530/3
con ganci e verniciato
with hook and painted



spess./thick. 3 mm
Ø 260 mm

Art. 1538/4
grezzo/unpainted

Art. 1536/4
con ganci - grezzo
with hook - unpainted

Art. 1532/4
verniciato/painted

Art. 1530/4
con ganci e verniciato
with hook and painted

Ø = diameter



spess./thick. 3 mm
Ø 260 mm

Art. 1538/5
grezzo/unpainted

Art. 1536/5
con ganci - grezzo
with hook - unpainted

Art. 1532/5
verniciato/painted

Art. 1530/5
con ganci e verniciato
with hook and painted



spess./thick. 3 mm
Ø 260 mm

Art. 1538/6
grezzo/unpainted

Art. 1536/6
con ganci - grezzo
with hook - unpainted

Art. 1532/6
verniciato/painted

Art. 1530/6
con ganci e verniciato
with hook and painted



spess./thick. 3 mm
Ø 260 mm

Art. 1538/7
grezzo/unpainted

Art. 1536/7
con ganci - grezzo
with hook - unpainted

Art. 1532/7
verniciato/painted

Art. 1530/7
con ganci e verniciato
with hook and painted



spess./thick. 3 mm
Ø 260 mm

Art. 1538/8
grezzo/unpainted

Art. 1536/8
con ganci - grezzo
with hook - unpainted

Art. 1532/8
verniciato/painted

Art. 1530/8
con ganci e verniciato
with hook and painted



spess./thick. 3 mm
Ø 260 mm

Art. 1539/1
grezzo/unpainted

Art. 1537/1
con ganci - grezzo
with hook - unpainted

Art. 1533/1
verniciato/painted

Art. 1531/1
con ganci e verniciato
with hook and painted



spess./thick. 3 mm
Ø 260 mm

Art. 1539/2
grezzo/unpainted

Art. 1537/2
con ganci - grezzo
with hook - unpainted

Art. 1533/2
verniciato/painted

Art. 1531/2
con ganci e verniciato
with hook and painted



spess./thick. 3 mm
Ø 260 mm

Art. 1539/3
grezzo/unpainted

Art. 1537/3
con ganci - grezzo
with hook - unpainted

Art. 1533/3
verniciato/painted

Art. 1531/3
con ganci e verniciato
with hook and painted



spess./thick. 3 mm
Ø 260 mm

Art. 1539/4
grezzo/unpainted

Art. 1537/4
con ganci - grezzo
with hook - unpainted

Art. 1533/4
verniciato/painted

Art. 1531/4
con ganci e verniciato
with hook and painted



spess./thick. 3 mm
Ø 260 mm

Art. 1539/5
grezzo/unpainted

Art. 1537/5
con ganci - grezzo
with hook - unpainted

Art. 1533/5
verniciato/painted

Art. 1531/5
con ganci e verniciato
with hook and painted



spess./thick. 3 mm
Ø 260 mm

Art. 1539/6
grezzo/unpainted

Art. 1537/6
con ganci - grezzo
with hook - unpainted

Art. 1533/6
verniciato/painted

Art. 1531/6
con ganci e verniciato
with hook and painted



spess./thick. 3 mm
Ø 260 mm

Art. 1539/7
grezzo/unpainted

Art. 1537/7
con ganci - grezzo
with hook - unpainted

Art. 1533/7
verniciato/painted

Art. 1531/7
con ganci e verniciato
with hook and painted



spess./thick. 3 mm
Ø 260 mm

Art. 1539/8
grezzo/unpainted

Art. 1537/8
con ganci - grezzo
with hook - unpainted

Art. 1533/8
verniciato/painted

Art. 1531/8
con ganci e verniciato
with hook and painted



spess./thick. 3 mm
Ø 260 mm

Art. 1539/9
grezzo/unpainted

Art. 1537/9
con ganci - grezzo
with hook - unpainted

Art. 1533/9
verniciato/painted

Art. 1531/9
con ganci e verniciato
with hook and painted



spess./thick. 3 mm
Ø 260 mm

Art. 1539/10
grezzo/unpainted

Art. 1537/10
con ganci - grezzo
with hook - unpainted

Art. 1533/10
verniciato/painted

Art. 1531/10
con ganci e verniciato
with hook and painted

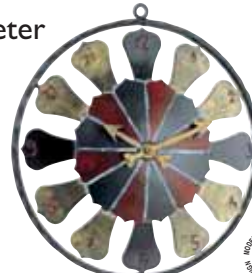

spess./thick. 3 mm
Ø 260 mm

Art. 1539/11
grezzo/unpainted

Art. 1537/11
con ganci - grezzo
with hook - unpainted

Art. 1533/11
verniciato/painted

Art. 1531/11
con ganci e verniciato
with hook and painted



spess./thick. 3 mm
Ø 260 mm

Art. 1539/12
grezzo/unpainted

Art. 1537/12
con ganci - grezzo
with hook - unpainted

Art. 1533/12
verniciato/painted

Art. 1531/12
con ganci e verniciato
with hook and painted

Ø = diameter



spess./thick. 3 mm
Ø 260 mm

Art. 1539/13
grezzo/unpainted

Art. 1537/13
con ganci - grezzo
with hook - unpainted

Art. 1533/13
verniciato/painted

Art. 1531/13
con ganci e verniciato
with hook and painted



spess./thick. 3 mm
Ø 260 mm

Art. 1539/14
grezzo/unpainted

Art. 1537/14
con ganci - grezzo
with hook - unpainted

Art. 1533/14
verniciato/painted

Art. 1531/14
con ganci e verniciato
with hook and painted



spess./thick. 3 mm
Ø 260 mm

Art. 1539/15
grezzo/unpainted

Art. 1537/15
con ganci - grezzo
with hook - unpainted

Art. 1533/15
verniciato/painted

Art. 1531/15
con ganci e verniciato
with hook and painted



spess./thick. 3 mm
Ø 260 mm

Art. 1539/16
grezzo/unpainted

Art. 1537/16
con ganci - grezzo
with hook - unpainted

Art. 1533/16
verniciato/painted

Art. 1531/16
con ganci e verniciato
with hook and painted



spess./thick. 3 mm
230 x 270 mm

Art. 1535/1
grezzo/unpainted
Art. 1534/1
verniciato/painted



spess./thick. 3 mm
200 x 230 mm

Art. 1535/2
grezzo/unpainted
Art. 1534/2
verniciato/painted



spess./thick. 3 mm
200 x 235 mm

Art. 1535/3
grezzo/unpainted
Art. 1534/3
verniciato/painted



spess./thick. 3 mm
240 x 255 mm

Art. 1535/4
grezzo/unpainted
Art. 1534/4
verniciato/painted



spess./thick. 3 mm
245 x 235 mm

Art. 1535/5
grezzo/unpainted
Art. 1534/5
verniciato/painted



spess./thick. 3 mm
190 x 220 mm

Art. 1535/6
grezzo/unpainted
Art. 1534/6
verniciato/painted



spess./thick. 3 mm
190 x 250 mm

Art. 1535/7
grezzo/unpainted
Art. 1534/7
verniciato/painted



spess./thick. 3 mm
210 x 230 mm

Art. 1535/8
grezzo/unpainted
Art. 1534/8
verniciato/painted



spess./thick. 3 mm
185 x 240 mm

Art. 1535/9
grezzo/unpainted
Art. 1534/9
verniciato/painted



spess./thick. 3 mm
210 x 250 mm

Art. 1535/10
grezzo/unpainted
Art. 1534/10
verniciato/painted



spess./thick. 3 mm
240 x 220 mm

Art. 1535/11
grezzo/unpainted
Art. 1534/11
verniciato/painted



spess./thick. 3 mm
240 x 170 mm

Art. 1535/12
grezzo/unpainted
Art. 1534/12
verniciato/painted



spess./thick. 3 mm
180 x 230 mm

Art. 1535/13
grezzo/unpainted
Art. 1534/13
verniciato/painted



spess./thick. 3 mm
215 x 190 mm

Art. 1535/14
grezzo/unpainted
Art. 1534/14
verniciato/painted



spess./thick. 3 mm
245 x 240 mm

Art. 1535/15
grezzo/unpainted
Art. 1534/15
verniciato/painted



spess./thick. 3 mm
205 x 245 mm

Art. 1535/16
grezzo/unpainted
Art. 1534/16
verniciato/painted





spess./thick. 3 mm
210 x 220 mm

Art. 1535/17
grezzo/unpainted

Art. 1534/17
verniciato/painted



spess./thick. 3 mm
190 x 240 mm

Art. 1535/18
grezzo/unpainted

Art. 1534/18
verniciato/painted



spess./thick. 3 mm
Ø 245 mm

Art. 1535/19
grezzo/unpainted

Art. 1534/19
verniciato/painted



spess./thick. 3 mm
230 x 250 mm

Art. 1535/20
grezzo/unpainted

Art. 1534/20
verniciato/painted



spess./thick. 3 mm
240 x 140 mm

Art. 1535/21
grezzo/unpainted

Art. 1534/21
verniciato/painted



spess./thick. 3 mm
230 x 230 mm

Art. 1535/22
grezzo/unpainted

Art. 1534/22
verniciato/painted



spess./thick. 3 mm
160 x 250 mm

Art. 1535/23
grezzo/unpainted

Art. 1534/23
verniciato/painted



spess./thick. 3 mm
160 x 250 mm

Art. 1535/24
grezzo/unpainted

Art. 1534/24
verniciato/painted



Art. 156/A/7
5 x 5 mm
Ø 35 mm

Art. 156/A/8
5 x 5 mm
Ø 40 mm

Art. 156/A/9
4,5 x 4,5 mm
19 x 50 mm

Art. 156/A/10
5 x 5 mm
15 x 35 mm

Art. 156/A/11
3,5 x 3,5 mm
12 x 40 mm

Art. 156/A/12
3,8 x 3,8 mm
9 x 28 mm

Le misure si riferiscono all'interno della maglia / Size refer to the inside width of the link
LUNGHEZZA delle CATENE = 10.000 mm (10 mt.) / CHAIN LONG = 10.000 mm (10 mt.)



ARTEFERRO

Art. 6318/I - L 3250 mm - H max 2650 mm



ARTEFERRO

Art. 6340/I - L 3240 mm - H max 2660 mm





ARTEFERRO

Art. 6346/I - L 3260 mm - H max 2855 mm



ARTEFERRO

Art. 6344/I - L 3240 mm - H max 2500 mm





ARTEFERRO

Art. 6322/I - L 3240 mm - H max 2490 mm



ARTEFERRO

Art. 6324/I - L 3240 mm - H max 2500 mm





ARTEFERRO

Art. 6320/I - L 1152 mm - H max 1960 mm



ARTEFERRO

Art. 6321/I - L 1120 mm - H max 2490 mm



ARTEFERRO

Art. 6326/I - L 1350 mm - H max 2380 mm



ARTEFERRO

Art. 6327/I - L 1240 mm - H max 2528 mm





Art. 6343/I - L 1350 mm - H max 2380 mm



Art. 6342/I - L 1050 mm - H max 2300 mm



Art. 6348/I - L 1240 mm - H max 2460 mm



Art. 6349/I - L 1050 mm - H max 2585 mm



L 1500 mm

Art. 6352/1

H 800 mm

Art. 6352/2

H 1000 mm

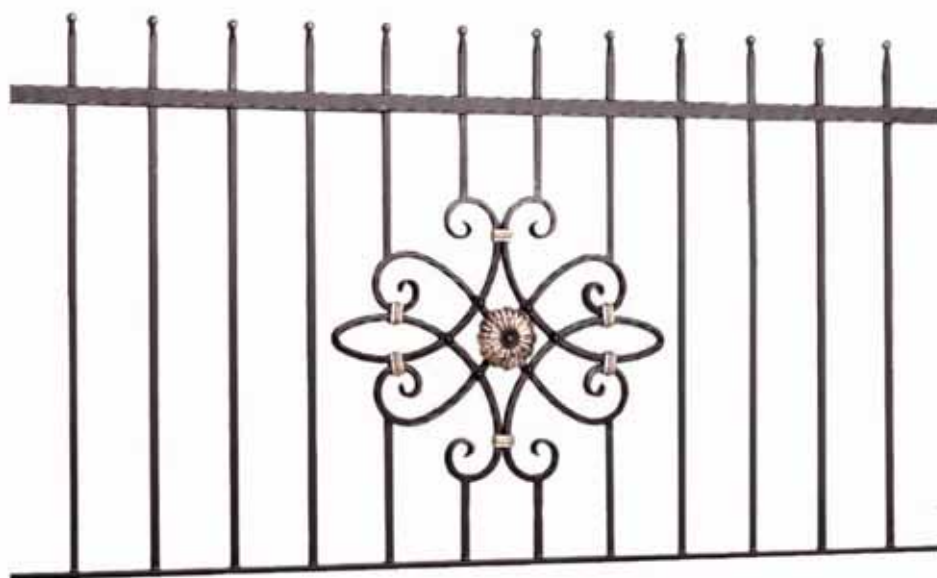

L 1500 mm

Art. 6353/1

H 800 mm

Art. 6353/2

H 1000 mm



L 1500 mm

Art. 6354/1

H 800 mm

Art. 6354/2

H 1000 mm

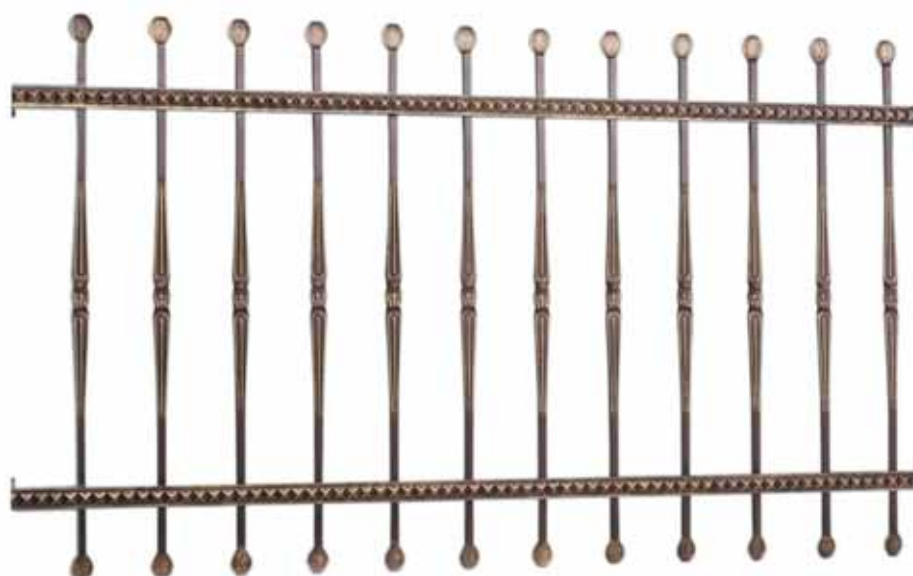



L 1500 mm

Art. 6356/1

H 800 mm

Art. 6356/2

H 1000 mm



L 1500 mm

Art. 6355/1

H 800 mm

Art. 6355/2

H 1000 mm

MONTANTI per PANNELLI MODULARI per RECINZIONI
NEWEL POSTS for MODULAR PANELS for FENCES



Per Pannelli/for panels H 800 mm

Art. 6356/3

H 1000 mm

Per Pannelli/for panels H 1000 mm

Art. 6356/4

H 1200 mm



Per Pannelli/for panels H 800 mm

Art. 6355/3

H 1000 mm

Per Pannelli/for panels H 1000 mm

Art. 6355/4

H 1200 mm



Per Pannelli/for panels H 800 mm

Art. 6352/3

H 1000 mm

Per Pannelli/for panels H 1000 mm

Art. 6352/4

H 1200 mm



Tondo Ø 22 mm a corteccia
Round iron dia 22 mm three effect

Tubo dia 22 mm - liscio
Round Tube iron dia 22 mm



L 1300 mm	Art. 889/1	Art. 889/2
L 1800 mm	Art. 889/3	Art. 889/4
L 2300 mm	Art. 889/5	Art. 889/6



Tondo Ø 22 mm a corteccia
Round iron dia 22 mm three effect

Tubo dia 22 mm - liscio
Round Tube iron dia 22 mm



L 1270 mm	Art. 889/8	Art. 889/7
L 1770 mm	Art. 889/10	Art. 889/9
L 2270 mm	Art. 889/12	Art. 889/11



Tondo Ø 22 mm a corteccia
Round iron dia 22 mm three effect

Tubo dia 22 mm - liscio
Round Tube iron dia 22 mm



L 1210 mm	Art. 889/13	Art. 889/14
L 1710 mm	Art. 889/15	Art. 889/16
L 2210 mm	Art. 889/17	Art. 889/18



Tondo Ø 22 mm a corteccia
Round iron dia 22 mm three effect

Tubo dia 22 mm - liscio
Round Tube iron dia 22 mm



L 1210 mm	Art. 889/20	Art. 889/19
L 1710 mm	Art. 889/22	Art. 889/21
L 2210 mm	Art. 889/24	Art. 889/23



Tondo Ø 22 mm a corteccia
Round iron dia 22 mm three effect

Tubo dia 22 mm - liscio
Round Tube iron dia 22 mm



L 1190 mm	Art. 889/25	Art. 889/26
L 1690 mm	Art. 889/27	Art. 889/28
L 2190 mm	Art. 889/29	Art. 889/30



Tondo Ø 22 mm a corteccia
Round iron dia 22 mm three effect

Tubo dia 22 mm - liscio
Round Tube iron dia 22 mm



L 1140 mm	Art. 889/32	Art. 889/31
L 1640 mm	Art. 889/34	Art. 889/33
L 2140 mm	Art. 889/36	Art. 889/35



Tondo Ø 22 mm a corteccia
Round iron dia 22 mm three effect

Tubo dia 22 mm - liscio
Round Tube iron dia 22 mm



L 1080 mm	Art. 889/37	Art. 889/38
L 1580 mm	Art. 889/39	Art. 889/40
L 2080 mm	Art. 889/41	Art. 889/42



Art. 885/1
 \square 20 x 4 mm
 155 x 120 mm



Art. 885/3
 \square 20 x 4 mm
 210 x 190 mm



Art. 885/4
 \square 25 x 3 mm
 230 x 180 mm



Art. 885/6
 \square 18 x 5 mm
 205 x 235 mm

Art. 885/2
 \square 20 x 4 mm
 205 x 150 mm

Art. 885/5
 \square 25 x 3 mm
 165 x 295 mm



Art. 885/7
 \square 20 x 8 mm
 310 x 240 mm



Art. 886/3
 \square 20 x 8 mm
 290 x 235 mm



Art. 886/1
 \square 20 x 4 mm
 245 x 220 mm



Art. 886/2
 \square 20 x 4 mm
 215 x 216 mm



Art. 886/4
 \square 12 x 12 mm
 215 x 255 mm

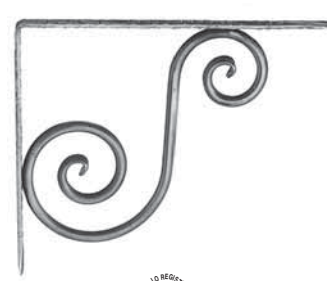

Art. 885/8
 \square 20 x 4 mm
 150 x 200 mm



Art. 1470/7
 \square 75 x 3 mm
 230 x 300 mm



Art. 1470/6
 \square 75 x 3 mm
 240 x 300 mm



Art. 1470/5
 \square 75 x 3 mm
 290 x 300 mm



Art. 1470/4
 \square 75 x 3 mm
 340 x 520 mm



Art. 1470/3
 \square 75 x 3 mm
 330 x 520 mm



Art. 1469/1
 \square 25 x 6 mm
 440 x 260 mm
 fessura/slit 6 mm



ARTEFERRO

Art. 1470/1

□ 16 x 8 mm

930 x 830 mm

Piatto di supporto

Support section

□ 40 x 6 mm



Art. 1470/2

□ 16 x 8 mm

620 x 760 mm

Piatto di supporto

Support section

□ 40 x 6 mm



Art. 200/2
470 x 520 mm

Portata
Carry well
kg 100 circa



Art. 902/6

grezzo/unpainted

Art. 10333/1

verniciato/unpainted

□ 12 x 12 mm

450 x 510 mm



Art. 902/4

grezzo/unpainted

Art. 10520/1

verniciato/unpainted

□ 14 x 14 mm

450 x 510 mm





Art. 170/8
450 x 35 mm

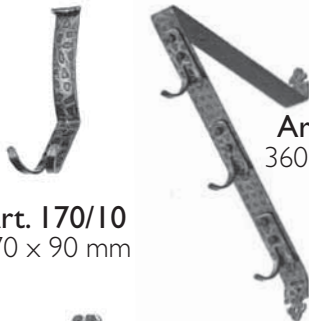

Art. 170/9
360 x 35 mm

Art. 170/10
170 x 90 mm



Art. 170/11
80 x 40 mm



Art. 170/12
170 x 105 mm



Art. 838/6
180 x 100 mm



Art. 838/7
130 x 110 mm



Art. 838/5
240 x 120 mm



Art. 168/1
300 x 60 mm



Portacandela
Candle Holder

Art. 10437/1
H 190 mm
base Ø 90 mm

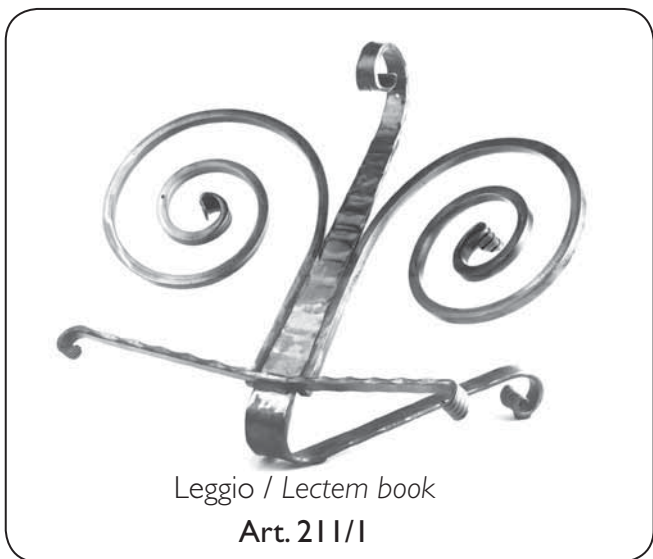

Leggio / Lectem book

Art. 211/1



Art. 1540/6
110 x 105 mm
spess./thick. 3 mm



110 x 105 mm
spess./thick. 3 mm

Art. 1540/7
per n. 2 barre/bars
12 x 6 mm

Art. 1540/8
per n. 3 barre/bars
12 x 6 mm

Art. 1540/9
per n. 4 barre/bars
12 x 6 mm

Art. 10539/1
H 1250 mm
tubo-tube Ø 50 mm



Art. 1540/1
H 530 mm
tubo-tube Ø50 mm

20 x 20 mm
base Ø 35 mm

Art. 888/2
H 610 mm

Art. 888/3
H 365 mm



Art. 10455/1
H 600 mm
L 1020 mm
P 530 mm



Art. 213/2
200 x 790 mm



Art. 10472/1
810 x 260 mm

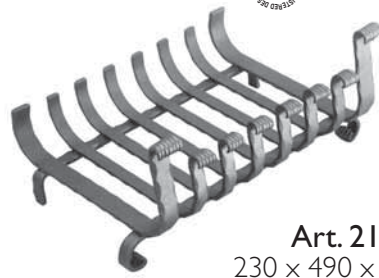

Art. 213/3
230 x 490 x 250 mm



Art. 10473/1
380 x 490 mm



Art. 213/4
200 x 510 x 400 mm



Art. 10473/2
520 x 610 mm



Art. 213/1
360 x 430 mm



Art. 10472/2
530 x 420 x 260 mm



Art. 10474/1
550 x 900 mm



Art. 10475/1
390 x 510 x 410 mm



Art. 10477/2
620 x 420 x 200 mm



Art. 10475/2
480 x 520 x 310 mm



Art. 10477/1
480 x 380 x 360 mm



Art. 1471/3006/0



1471/3006/1

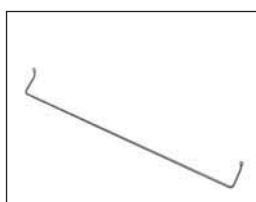

1471/3006/2

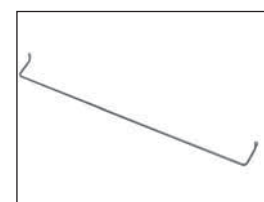

1471/3006/3

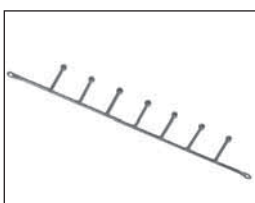

1471/3006/4



1471/3006/5



1471/3006/6



1471/3006/7



1471/3006/8



1471/3006/9

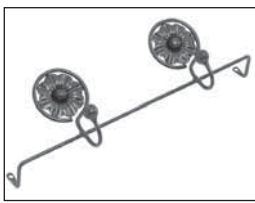

1471/3006/10

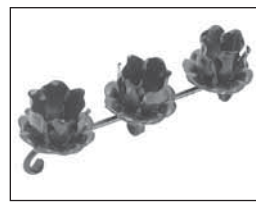

1471/3006/11



1471/3006/12



1471/3006/13

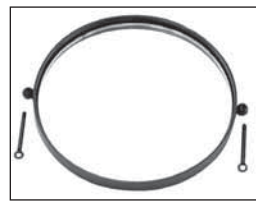

1471/3006/14



1471/3006/15

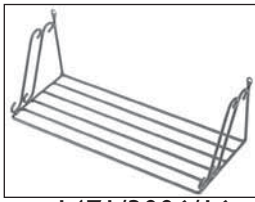

1471/3006/16

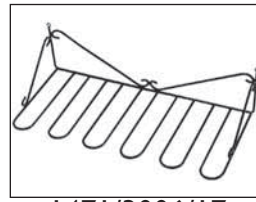

1471/3006/17



1471/3006/18



1471/3006/19

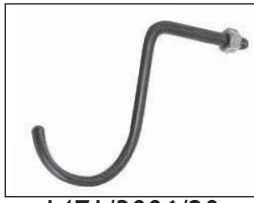

1471/3006/20



1471/3006/21



1471/3006/22



1471/3006/23



1471/3006/24



1471/3006/25



1471/3006/26



1471/3006/27



1471/3006/28



1471/3006/29



1471/3006/30

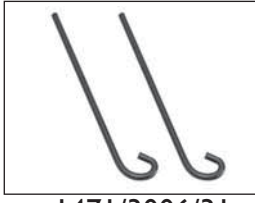

1471/3006/31



1471/3006/32



1471/3006/33



Via Vicenza, 6/14
36034 Malo (Vicenza) ITALY
TEL. (+39) 0445 580 580
FAX (+39) 0445 580 874
E-mail: india@arteferro.com
www.arteferro.com - www.arteferroinox.com
www.ilgrandefabbro.com - www.ironews.com



HOUSTON - U.S.A.

7947 MESA ROAD - HOUSTON
TEXAS 77028 - U.S.A.
PHONE: (+1) (713) 694-6065 / 1-800-772-4706
FAX: (+1) (713) 694-2055
www.indital.com - forgings@indital.com



MIAMI - U.S.A.

2955 N.W. 75th STREET
MIAMI, FLORIDA 33147 - USA
PHONE: (+1) (305) 836-9232 / 1-877-723-6743
FAX: (+1) (305) 836-4113
www.arteferromiami.com info@arteferromiami.com



AVELLINO - ITALY

Via Piano Alvanella 83024 MONTEFORTE IRPINO (AV)
Tel. (+39) 0825 68 00 81
Fax (+39) 0825 68 34 98
(Per Campania - Puglia - Calabria - Basilicata - Molise)
www.arteferrosud.it info@arteferrosud.it



FRANCE

Z.A.E. LA BAUME RN 113 - 34290 SERVIAN FRANCE
TEL. (+33) (0) 4.67.39.42.81 (lignes groupées)
Fax (+33) (0) 4.67.39.20.90
www.franceindia.com
france.india@wanadoo.fr



SPAIN

28500 ARGANDA DEL REY (MADRID) - ESPAÑA
C/ ABEDUL, 43 - Poligono "EL GUIJAR"
TEL. (+34) (91) 8701897 - 8700819
FAX (+34) (91) 8700820
info@arteferro.es www.arteferro.es



CROATIA

SIRKOVISCE bb 40324 GORICAN - HRVATSKA
PHONE (+385) (0)40 602 - 222
Fax PHONE (+385) (0)40 602-230
www.arteferro-dohomont.hr
info@arteferro-dohomont.hr



ROMANIA

Targoviste - Romania Soseaua Gaesti, (sat Colanu)
Judetul Dambovitia
Tel. (004) 0751060204, (004) 0745395590
Fax (004) 0745731210
E-mail: info@mobillforge.com



РОССИЯ

603092 Nizhny Novgorod (Russia)
Moskovskoje shosse, 320 B
TEL. (+7) (831) 296-19-99 FAX: (+7) (831) 279-28-63
www.arteferro.ru - info@arteferrorussia.com



UKRAINE

5, AVTOPARKOVA, 02660 Kiev - Ukraine
Tel.: (+38) (044) 4920331
Fax: (+38) (044) 4920332
E-mail: arteferroukraina@svitonline.com
www.arteferroukraina.com



POLAND

ul. Gierdziewskiego 7
02-495 Warszawa POLAND
Tel +48 (22) 397-79-40
Fax +48 (22) 397-21-55
info@indiapoland.com - www.indiapoland.com



MEXICO

Av. E. Martinez Lara # 117 Parque Industrial MILIMEX
Carretera Sta. Rosa Km. 3 Apodaca,
Nuevo León C.P. 66637
Teléfono: (81) 1295-5094 / 1295-5095 - Fax: (81) 1295-5097
info@arteferromonterrey.com www.arteferromonterrey.com



BRASIL

RUA PADRE FEIJÓ, 480 CEP 95190-000
SÃO MARCOS / RS BRASIL
TEL. - FAX (+55) (0) 54 32911416
www.arteferrobrasil.com.br
arteferro@arteferrobrasil.com.br



ARGENTINA

Suarez 760
(1162) Capital Federal Buenos Aires
Republica Argentina
TEL./Fax (+54) 11 43012637
www.laherreria.com



CHILE

LOS ARRAYANES 250,
COMUNA DE COLINA,
SANTIAGO DE CHILE
TEL./FAX (+56) 2 738 7419
www.arteferrochile.cl



SKANDINAVIEN

BRODALSVÄGEN 7 HUS X 433 38
PARTILLE - SWEDEN
TEL. +46 (0) 31 444060 - FAX. +46 (0) 31 444511
www.arteferroinox.se
info@arteferroinox.se

